



Everywhere, that's where I want to go

GENERAL CATALOGUE 2021

For 75 years quality and technology on the road

Travelling on board a motorhome is the best way to get to know the world. In absolute freedom, you can decide when to leave and where to stop. With friends or family, by the sea or at the foot of a mountain, you can imagine the trip you want, if your vehicle has Fiamma products.

The quality of each item, tested in the laboratory and then on the road, along with professional assistance always available will make every trip an unforgettable moment of dolce vita.

– >>> **Founded in Italy in 1945, Fiamma is an international leader in the development of technical accessories to convert your vehicle into the ideal vehicle for every adventure. Its products offer you technology and quality without boundaries.**





1
logistics and
design centre



100,000
spare parts in
stock



8
production units



100
patents



FIAMMASTORE

FiammaStore	6
Wall installation	12
Roof installation	22
Rail installation	30
Motor-Kit	36
Awning accessories	38
Panels and enclosures	42
Side and front	44
Enclosures	48
Complete awning with enclosure	58
Rear door enclosures	62
Skirting for wind protection	63
Enclosures accessories	64

CARRY-BIKE

Carry-Bike	66
Motorhome	70
Caravan	78
Campervan	82
Van conversions	90
SUV	94
Garage	96
Accessories	100
Rear Boxes	108

COMFORT

Comfort	110
Rooflights	112
Lighting	120
Water	124
Level systems	128
Organisation	132
Safety	140
Ladders	144
Hygiene	146
Vehicle covers	148
Mix	150



AWNINGS

Practical and fast, they will shelter you on the sunniest days.



ACCESSORIES

Thanks to the wide range of accessories, you can customise each solution.



PANELS

Effective and robust, you can mount them on the sides and/or at the front.



ENCLOSURES

Large and comfortable, they create a safe and cosy environment.

FIAMMASTORE

The world is your home

Get in your vehicle and set off to discover the world. Fiammastore products are the ideal travel companions for your holidays, trips and excursions. Whatever your vehicle, it only takes a few gestures to expand the space available to you.

Awnings, panels and enclosures will protect you from the weather and increase your privacy, wherever you decide to stay.

Fiamma awnings are designed to protect your moments of relaxation from the sun. Easy to install, simple and functional, they were created to offer you a solution with an essential design, customisable according to your preferences and suitable to be fitted on any vehicle.



WALL INSTALLATION

It is the most used type, because the wide range of brackets makes it compatible with most vehicles.



ROOF INSTALLATION

Extremely compact, it is installed on the roof of the vehicle thanks to special brackets, integrating perfectly with the aesthetics.



RAIL MOUNTING

Lightweight and easy removable with a single gesture, it uses the caravan's rail without any brackets.

AWNINGS

Live in the open air comfortably



Selection guide



F45s



F45L



F45eagle



Compass



Slide Out

Installation	wall installation	wall installation	wall installation	wall installation	wall installation
Vehicle					
Length	190-450 cm	450-500 cm	350-450 cm	220-260 cm	170-280 cm
Motor	optional motor	optional motor	motorised	-	-
Case box finishes	<ul style="list-style-type: none"> Polar White Titanium Deep Black 	<ul style="list-style-type: none"> Polar White Titanium 	<ul style="list-style-type: none"> Polar White 	<ul style="list-style-type: none"> Silver Black 	<ul style="list-style-type: none"> Polar White Deep Black







F80s

roof installation



290-450 cm

optional motor

-  Polar White
-  Titanium
-  Deep Black





F65L

roof installation



400-490 cm

optional motor

-  Polar White
-  Titanium
-  Deep Black





F65eagle

roof installation



350-450 cm

motorised

-  Polar White
-  Titanium



F40van

roof installation



270 cm

-

-  Deep Black





CARAVANSTORE / XL

rail mounting



190-550 cm

-

-  Grey
-  Black





F35pro

wall / roof / rail



180-300 cm

-

-  Titanium
-  Deep Black



F45s

Suitable for all vehicles, it is a flexible solution that combines pure functionality with a minimalist contemporary look.

- winch with visible loop
- optional electric motor (page 39)



F45s

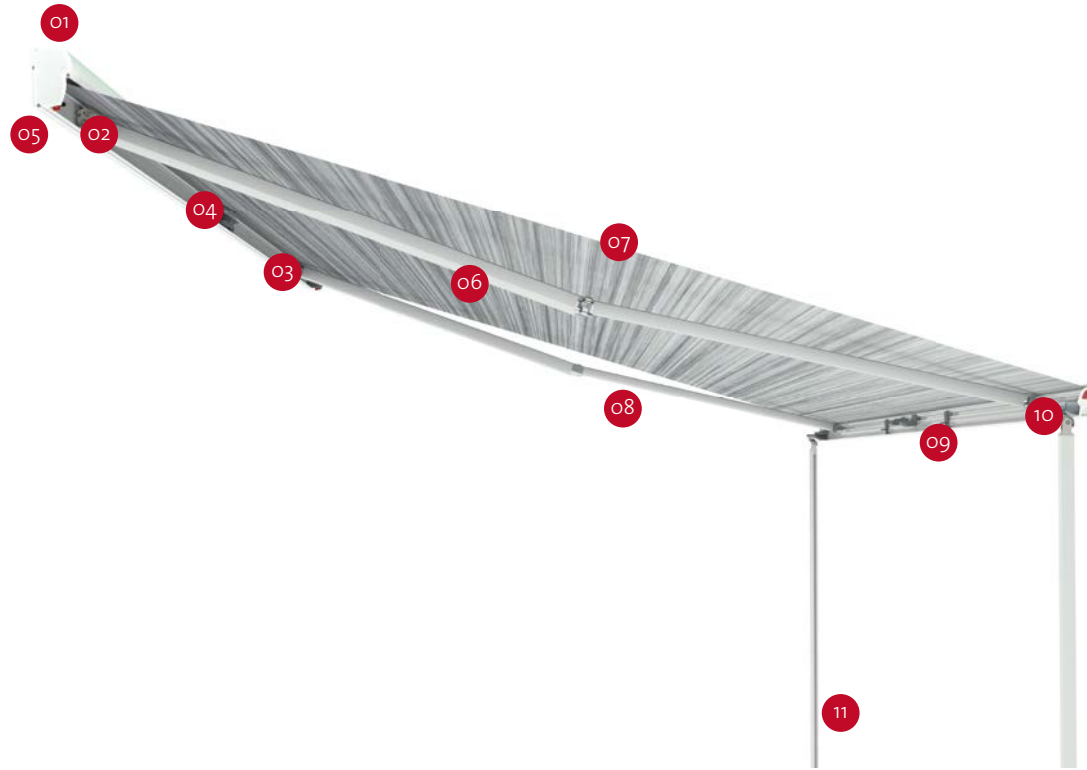

- | | | | |
|---|--|---|---|
| <p>01 Brackets
Standard equipment. More than 90 types of dedicated brackets available on request</p> | <p>02 Presto Fix
Guarantees perfect closure of the lead bar over time</p> | <p>03 Dual Shock-Absorber
Absorbs shocks in case of heavy stress</p> | <p>04 Roller support
Facilitates the rolling up of the fabric</p> |
| <p>05 Dual Security
Indicator for correct closure of the lead bar</p> | <p>06 Reinforced arms
Keep the fabric tensioned</p> | <p>07 One Way Roll
Guides the direction of rolling up</p> | <p>08 LEDs
The cable ducts on the arms allow the passage of cables for the optional Fiamma LED kits (page 122)</p> |
| <p>09 Double guide
Allows the installation of two front panels and other accessories</p> | <p>10 Leg
Telescopic and equipped with a reinforced joint</p> | <p>11 Secure Lock
Adjusts the height of the lead bar</p> | |



☰ CUSTOMIZE YOUR AWNING

Case box finishes

Fabric finishes

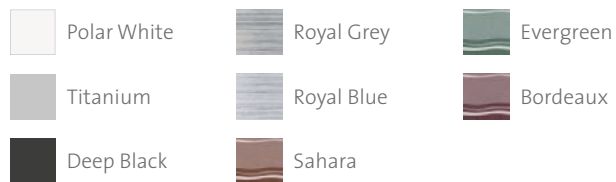

For more technical and commercial information, see page 152

F45s	Extension	Weight
190	1,00 m	11,5 kg
230	1,50 m	16,5 kg
260	2,00 m	19,5 kg
300		23,0 kg
350		25,0 kg
375	2,50 m	26,0 kg
400		27,0 kg
425		28,2 kg
450		29,5 kg

+ ADD TO YOUR FIAMMA F45s

Enclosures - See page 48

- Privacy Room
- Privacy Room Light
- Privacy Ultra Light

Panels - See page 44

- Blocker Pro
- Blocker
- Sun View XL
- Side W Pro
- Side W Pro Shade
- Sun View Side

Accessories

- Motor Kit
- LED
- Rafter / Pro
- Magicrafter / Pro
- Tie Down / S
- Kit Rain Guard
- Kit Awning Pegs
- Kit Awning Plate
- Kit Awning Hangers
- Shade Sun View
- Spoiler S
- Patio-Mat
- Kit Repair Plus



Adapters



F45s campervan

Two specific versions for:

- VW T5 / T6 / T6.1 campervan
- PSA group campervan

VW version also suitable for short and long wheelbase multivan (Volkswagen transporter with C-rail) and California.

- winch with visible loop
- Specific brackets included
- optional electric motor (page 39)

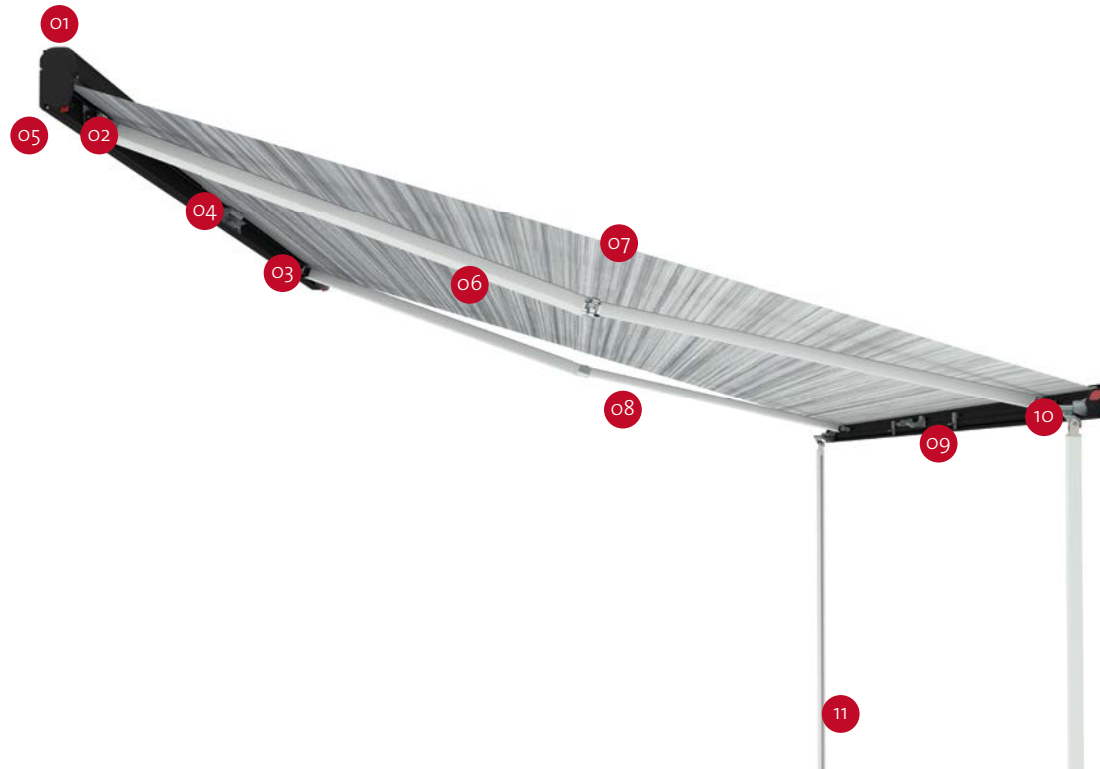

01 Brackets
Specific installation kit included

02 Presto Fix
Guarantees perfect closure of the lead bar over time

03 Dual Shock-Absorber
Absorbs shocks in case of heavy stress

04 Roller support
Facilitates the rolling up of the fabric

05 Dual Security
Indicator for correct closure of the lead bar

06 Reinforced arms
Keep the fabric tensioned

07 One Way Roll
Guides the direction of rolling up

08 LEDs
The cable ducts on the arms allow the passage of cables for the optional Fiamma LED kits (page 122)

09 Double guide
Allows the installation of two front panels and other accessories

10 Leg
Telescopic and equipped with a reinforced joint

11 Secure Lock
Adjusts the height of the lead bar



CHOOSE THE AWNING ACCORDING TO YOUR VEHICLE

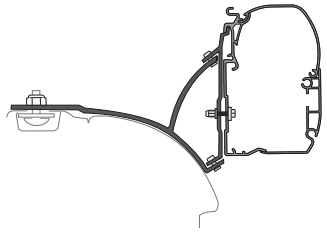

F45s VW T5/T6

Modello		Short wheelbase	Long wheelbase
VW T5/T6 senza guida a C	Awning	F45s 260 standard	-
	Adapter	optional	-
VW T5/T6 con guida a C	Awning	F45s VW T5/T6	F45s VW T5/T6
	Adapter	included in the awning	included in the awning
VW T5/T6 California	Awning	F45s VW T5/T6	-
	Adapter	included in the awning	-
VW T5/T6 con Multirail Reimo	Awning	F45s 260 standard	-
	Adapter	optional	-
VW T5/T6 con Top-rail Brandrup	Awning	F45s 260 standard	-
	Adapter	optional	-

For more technical and commercial information, see page 153

Case box finishes

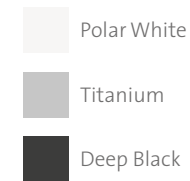

Fabric finishes



F45s VW T5/T6	Estensione	Peso
260	2,00 m	19,5 kg
300		22,0 kg

CHOOSE THE AWNING ACCORDING TO YOUR VEHICLE

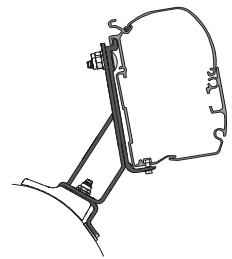

F45s PSA

Brand	Model	Year	Height	Vehicle length	F45s PSA
Citroën	Spacetourer	> 2016	H1 1890 mm	L 4956 mm	F45s PSA complete with installation kit dedicated to PSA group camper vans
	Jumpy	> 2016			
Opel / Vauxhall	Vivaro	> 2016			
	Zafira Life	> 2019			
Peugeot	Traveller	> 2016			
	Expert	> 2016			
Toyota	ProAce Verso	> 2016			
	Proace	> 2016			

For more technical and commercial information, see page 153

Case box finishes

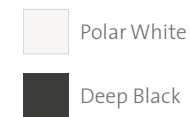

Finiture teli



F45s PSA	Estensione	Peso
260	2,00 m	19,5 kg

F45L

A large shaded area for your family. It is a wall awning with the oversized case box and extra-large roller, suitable for large motorhomes.

- winch with visible loop
- optional electric motor (page 39)



F45L

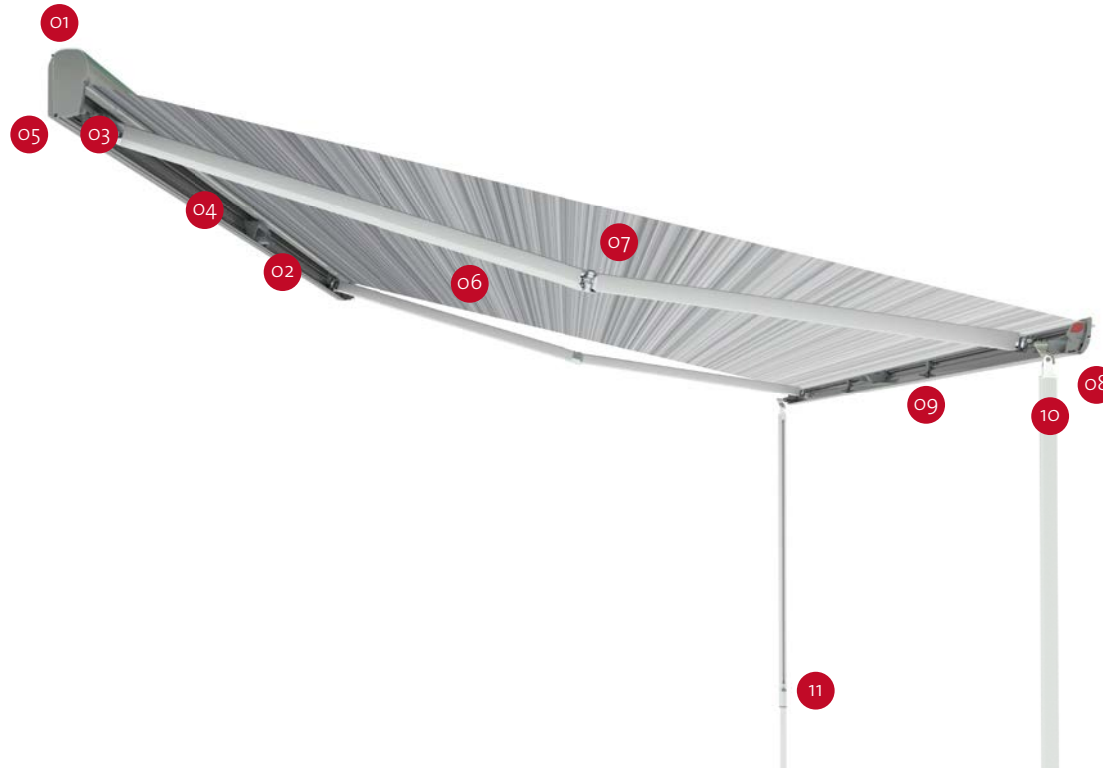

- | | | | |
|---|--|---|---|
| <p>01 Brackets
Standard equipment. More than 90 types of dedicated brackets available on request</p> | <p>02 Presto Fix
Guarantees perfect closure of the lead bar over time</p> | <p>03 Dual Shock-Absorber
Absorbs shocks in case of heavy stress</p> | <p>04 Roller support
Facilitates the rolling up of the fabric</p> |
| <p>05 Dual Security
Indicator for correct closure of the lead bar</p> | <p>06 Reinforced arms
Keep the fabric tensioned</p> | <p>07 One Way Roll
Guides the direction of rolling up</p> | <p>08 LEDs
The cable ducts on the arms allow the passage of cables for the optional Fiamma LED kits (page 122)</p> |
| <p>09 Double guide
Allows the installation of two front panels and other accessories</p> | <p>10 Leg
Telescopic and equipped with a reinforced joint</p> | <p>11 Secure Lock
Adjusts the height of the lead bar</p> | |



☰ CUSTOMIZE YOUR AWNING

Case box finishes



Fabric finishes

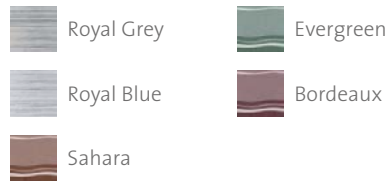

For more technical and commercial information, see page 153

Length	Extension	Weight
450	2,50 m	39.0 kg
500		42.5 kg
550		46.5 kg

+ ADD TO YOUR FIAMMA F45L

Enclosures - See page 48

- Privacy Room
- Privacy Ultra Light

Panels - See page 44

- Blocker Pro
- Blocker
- Sun View XL
- Side W Pro
- Side W Pro Shade
- Sun View Side

Accessories

- Motor Kit
- LED
- Rafter / Pro
- Magicrafter / Pro
- Tie Down / S
- Kit Rain Guard
- Kit Awning Pegs
- Kit Awning Plate
- Kit Awning Hangers
- Shade Sun View
- Spoiler S
- Patio-Mat
- Kit Repair Plus



Adapters



F45eagle

Automatic awning, wall installation. Control System wall control, without legs, equipped with self-supporting arms.

- motorised
- self-supporting arms



F45eagle

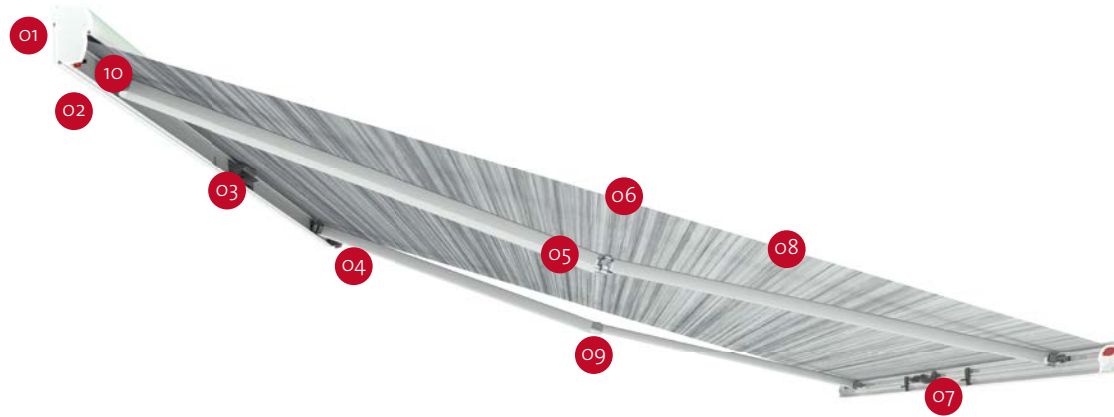

- 01 **Brackets**
Full length adapter supplied as standard
- 02 **Presto Fix**
Guarantees perfect closure of the lead bar over time
- 03 **Roller support**
Facilitates the rolling up of the fabric
- 04 **Motor**
Equipped with 12 V motor
- 05 **Reinforced arms**
Keep the fabric tensioned
- 06 **One Way Roll**
Guides the direction of rolling up
- 07 **Double guide**
Allows the installation of two front panels and other accessories
- 08 **Wind Detection System**
Sensor that is automatically activated and closes the awning in case of strong wind
- 09 **LEDs**
The cable ducts on the arms allow the passage of cables for the optional Fiamma LED kits (page 122)
- 10 **Double Block support**
Allows the regulation of the inclination from 5° to 17° and reinforces the self-supporting arms, thus avoiding the use of support legs



☰ CUSTOMIZE YOUR AWNING

Case box finishes

Fabric finishes



Polar White



Royal Grey

For more technical and commercial information, see page 154

Length	Extension	Weight
350		33.5 kg
400	2.50 m	36.5 kg
450		39.5 kg

+ ADD TO YOUR FIAMMA F45eagle

Accessories

- LED
- Kit Rain Guard
- Patio-Mat
- Shade Sun View



SlideOut

Ideal for vehicles with extendable rear or side panels to protect them from the sun and the effects of the weather.

- standard brackets included
- available in three lengths



SlideOut



01 Brackets
Standard equipment

02 Sheet extension
Automatic, up to one metre

03 Protecting
Against the harmful effects of weather

04 Spring
Pre-loaded, interior for rolling up and extension



 CUSTOMIZE YOUR AWNING

Case box finishes

Fabric finishes

 Polar White

 Royal Grey

 Deep Black

For more technical and commercial information, see page 154

SlideOut	Extension	Weight
170		6,3 kg
198	1.00 m	7,3 kg
278		10 kg



F80s

The optimal solution for roof installations, winning performance thanks to the triple guide on the lead bar and the double LED arrangement. It integrates perfectly with the shape of the vehicle.

- winch with visible loop
- optional electric motor (page 38)



F80s

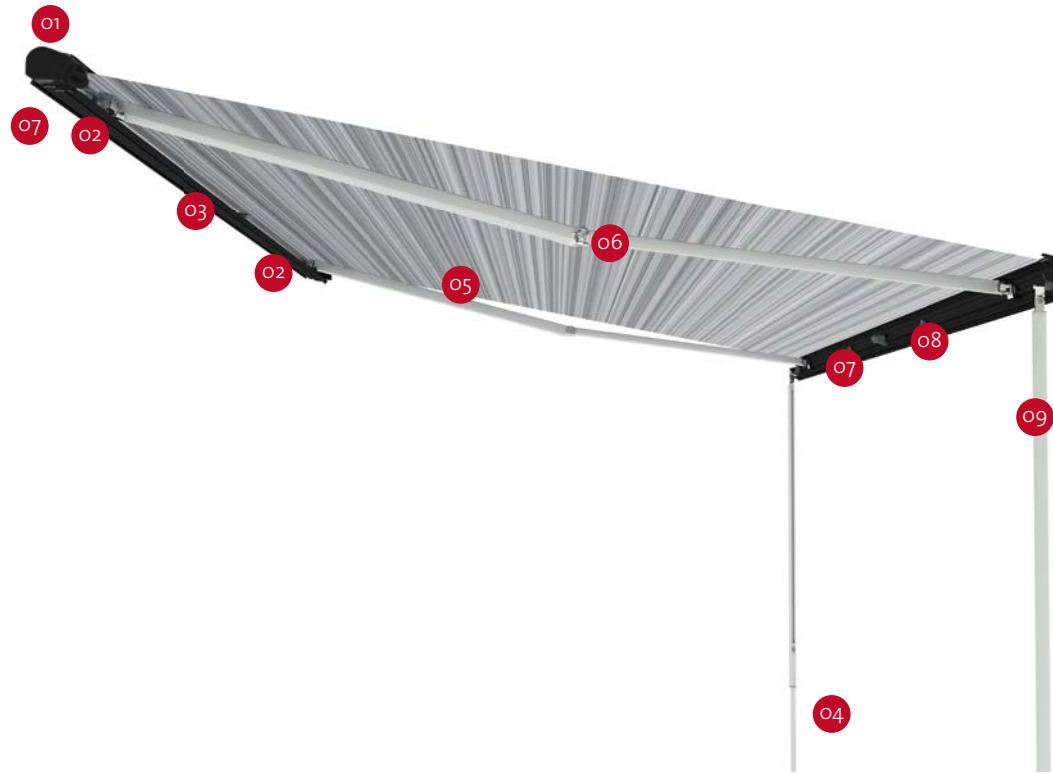

- 01 Brackets**
More than 40 types of dedicated brackets available on request
- 02 Dual Shock-Absorber**
Absorbs shocks in case of heavy stress
- 03 Roller support**
Facilitates the rolling up of the fabric
- 04 Secure Lock**
Adjusts the height of the lead bar
- 05 Reinforced arms**
Keep the fabric tensioned
- 06 One Way Roll**
Guides the direction of rolling up
- 07 LEDs**
Double front LED arrangement + case box
- 08 Triple guide**
Allows the installation of two front panels and other accessories
- 09 Leg**
Telescopic and equipped with a reinforced joint



☰ CUSTOMIZE YOUR AWNING

Case box finishes

Fabric finishes



Polar White



Royal Grey



Titanium

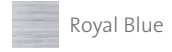

Royal Blue

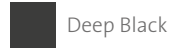

Deep Black

For more technical and commercial information, see page 155

F80s	Extension	Weight
290	2.00 m	27.0 kg
320	2.50 m	29.0 kg
340		30.0 kg
370		32.0 kg
400		34.0 kg
425		35.0 kg
450		36.5 kg

+ ADD TO YOUR FIAMMA F80S

Enclosures - See page 48

- Privacy Room
- Privacy Room Light
- Privacy Ultra Light

Panels - See page 44

- Blocker Pro
- Blocker
- Sun view XL
- Side W Pro
- Side W Pro Shade
- Sun View Side

Accessories

- Motor Kit
- LED
- Rafter / Pro
- Magicrafter / Pro
- Tie Down / S
- Kit Rain Guard
- Kit Awning Pegs
- Kit Awning Plate
- Kit Awning Hangers
- Shade Sun View
- Patio-Mat
- Kit Repair Plus



F65L

Elegant, compact and robust.
Particularly suitable for large vehicles.

- winch with visible loop
- optional electric motor (page 39)



F65L



- | | | | | |
|---|--|---|--|---|
| <p>01 Brackets
More than 40 types of dedicated brackets available on request</p> | <p>02 Dual Shock-Absorber
Absorbs shocks in case of heavy stress</p> | <p>03 Roller support
Facilitates the rolling up of the fabric</p> | <p>04 Reinforced arms
Keep the fabric tensioned</p> | |
| <p>05 One Way Roll
Guides the direction of rolling up</p> | <p>06 LEDs
Equipped with guide in the lead bar for optional LED kit</p> | <p>07 Double guide
Allows the installation of two front panels and accessories</p> | <p>08 Leg
Telescopic and equipped with a reinforced joint</p> | <p>09 Secure Lock
Adjusts the height of the lead bar</p> |



☰ CUSTOMIZE YOUR AWNING

Case box finishes

Fabric finishes



Polar White



Royal Grey



Titanium



Royal Blue



Deep Black

For more technical and commercial information, see page 156

F65L	Extension	Weight
400		36.0 kg
450	2,50 m	41.0 kg
490		44.5 kg

+ ADD TO YOUR FIAMMA F65 L

Enclosures - See page 48

- Privacy Room
- Privacy Ultra Light

Panels - See page 44

- Blocker Pro
- Blocker
- Sun view XL
- Side W Pro
- Side W Pro Shade
- Sun View Side

Accessories

- Motor Kit
- LED
- Rafter / Pro
- Magicrafter / Pro
- Tie Down / S
- Kit Rain Guard
- Kit Awning Pegs
- Kit Awning Plate
- Kit Awning Hangers
- Shade Sun View
- Patio-Mat
- Kit Repair Plus



Adapters



F65eagle

Automatic awning, roof installation. Control System wall control, without legs, equipped with self-supporting arms.

- motorised



F65eagle



- 01 **Brackets**
Included for the Ducato version. Optional for standard version (400 cm)
- 02 **Presto Fix**
Guarantees perfect closure of the lead bar over time
- 03 **Roller support**
Facilitates the rolling up of the fabric
- 04 **Motor**
Equipped with 12 V motor
- 05 **Reinforced arms**
Keep the fabric tensioned
- 06 **One Way Roll**
Guides the direction of rolling up
- 07 **Double guide**
Allows the installation of two front panels and other accessories
- 08 **Wind Detection System**
Sensor that is automatically activated and closes the awning in case of strong wind
- 09 **LEDs**
The cable ducts on the arms allow the passage of cables for the optional Fiamma LED kits (page 122)
- 10 **Double Block support**
Allows the regulation of the inclination from 5° to 17° and reinforces the self-supporting arms, thus avoiding the use of support legs



 CUSTOMIZE YOUR AWNING

Case box finishes

Fabric finishes

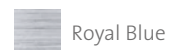

For more technical and commercial information, see page 156

F65eagle	Extension	Weight
319	2.50 m	30.0 kg
369		34.0 kg
399		37.0 kg
400		37.5 kg

 ADD TO YOUR FIAMMA F65eagle

Accessories

- LED
- Kit Rain Guard
- Patio-Mat
- Shade Sun View



F40van

Specific for campervan, reduced section that guarantees compact dimensions and aerodynamics. The lowered brackets make it quick and easy to remove.

- winch with visible loop



F40van



01 Brackets
Wide range of brackets that can be purchased separately

02 Reinforced arms
With reduced section

03 One Way Roll
Guides the direction of rolling up

04 One guide
Allows the installation of front panels and accessories

05 Flat legs
With predefined position for fast and precise opening



 CUSTOMIZE YOUR AWNING

Case box finishes

Fabric finishes

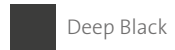

For more technical and commercial information, see page 157

F40van	Extension	Weight
270	2,25 m	19,0 kg

 ADD TO YOUR F40VAN

Enclosures - See page 48

- Room Van Premium
- Room Van

Panels - See page 44

- Side W Pro
- Sun View XL

Accessories

- Tie Down
- Kit Rain Guard
- Kit Awning Pegs
- Kit Awning Plate
- Kit Awning Hangers
- Shade Sun View
- Patio-Mat
- Kit Repair Plus



Adapters



CaravanStore / XL

Specific for caravans, simple and easy to install, with quick opening and closing ensuring stability and safety.

- manual
- installation on rail



CaravanStore / XL



01 Installation
On rail: fast, quick and easy

02 Bag
Comfortable and soft anti-scratch tape

03 Easy regulation
Arm adjustment system with different fabric extension positions

04 Integrated legs
Stored in the roller, telescopic and easy to take out

05 Wall fixing
Rubber kit to provide protection to the side wall of the vehicle

06 Double guide
Allows the installation of two front panels and accessories



07 Roller
Rolling up of the fabric in both directions

08 LEDs
Option to illuminate the environment thanks to the optional kits





☰ CUSTOMIZE YOUR AWNING

Bag finishes

-  Grey
-  Deep Black

Fabric finishes

-  Royal Grey
-  Royal Blue

For more technical and commercial information, see page 157

CaravanStore /XL	Extension	Weight
190	1,80 m	6,0 kg
225	2,25 m	7,5 kg
264		8,5 kg
280	2,50 m	10,1 kg
310		11,2 kg
360		12,3 kg
410		13,5 kg
440		14,6 kg
500		15,8 kg
550		16,9 kg

+ ADD TO YOUR FIAMMA CARAVANSTORE / XL

Enclosures - See page 48

- Privacy Room CS Light / XL

Panels - See page 44

- Blocker Pro
- Blocker
- Sun View XL
- Side W Pro
- Side W CaravanStore
- Sun View Side

Accessories

- Tie Down S CaravanStore
- Rafter CaravanStore / XL
- Rafter LED
- Kit Awning Pegs
- Kit Awning Plate
- Kit Awning Hangers
- Shade Sun View 550
- Patio-Mat
- Kit Repair Plus



Adapters



F35pro

The lightweight and robust awning in aluminium for your caravan, campervan and 4x4.

- manual
- easy installation on the wall, on roof bars or rail



F35pro



- | | | |
|--|--|---|
| <p>01 Brackets
Wide range of brackets that can be purchased separately</p> | <p>02 Compact case box
The awning is contained in a comfortable anodised aluminium case box</p> | <p>03 Double guide
Allows the installation of two front panels and accessories</p> |
| <p>04 Integrated legs
Stored in the roller, telescopic and easy to take out</p> | <p>05 Reinforced arms
Keep the fabric tensioned</p> | <p>06 Roller
Rolling up of the fabric in both directions</p> |



☰ CUSTOMIZE YOUR AWNING

Case box finishes

Fabric finishes



Titanium



Royal Grey



Deep Black



Royal Blue

For more technical and commercial information, see page 158

F35pro	Extension	Weight
180	1,80m	8,5 kg
220	2,25 m	10,5 kg
250		11,5 kg
270		13,0 kg
300		14,0 kg

+ ADD TO YOUR FIAMMA F35pro

Enclosures - See page 48

Panels - See page 44

Accessories

- Privacy CS Light / XL

- Blocker Pro
- Blocker
- Sun view XL
- Side W Pro
- Side W CS / F35
- Side W Pro Shade
- Sun View Side

- Tie Down S CaravanStore
- Rafter CaravanStore
- Safety Strip
- Kit Awning Pegs
- Kit Awning Plate
- Kit Awning Hangers
- Shade Sun View 550
- Patio-Mat
- Kit Repair Plus



Staffe



Compass

Suitable for camper vans and off-road vehicles, 270° circular compass opening, perfect for any occasion.

- manual awning
- compass opening
- suitable for camper vans and 4x4 vehicles



Compass



01 Brackets
Can be purchased separately

02 Compass opening
270° opening around the vehicle

03 Vertical support
For a canopy that is always well tight

04 Fabric
Attached to the bag with a sturdy zipper, easily removable

05 Bag
Super strong and UV-resistant, with sturdy zipper closure

06 Resistant to torsion
Guaranteed thanks to the robust aluminium structure

07 Secure Lock
Adjusts the height of the lead bar



☰ CUSTOMIZE YOUR AWNING

Bag finishes



Silver

Fabric finishes



Light Grey



Black

For more technical and commercial information, see page 158

Compass	Shade surface	Weight
220 *	7,2 m ²	16,5 kg
260 *	9,9 m ²	19,5 kg

* Only suitable for left hand drive vehicles

+ ADD TO YOUR FIAMMA COMPASS

Accessories

- Kit Awning Pegs
- Kit Awning Plate
- Kit Awning Hangers
- Patio-Mat
- Kit Repair Plus



Adapters



Motor Kit

To motorise your awning, they integrate perfectly with the model which they are designed.

- 12 V motor
- equipped with Control System
- available for: F45, F65 and F80 in 3 different variants



Motor Kit

COMPACT MOTOR F80s KIT

12 V Motor Kit complete with headset and wall control panel Control System, which allows you to conveniently operate the motor via the wall button.



MOTOR KIT FOR PLUS F80s

Equipped with infrared remote control and wall control of the Motor kit. The control unit allows the self-tensioning of the canopy on opening and the opening and closing operations also with the "one touch" automotive system.



MOTOR KIT FOR ADVANCED F80s

Thanks to the practical Fiamma App (for Android or iOS systems), it is possible to manage the F80s awning from your own device: opening and closing the awning, LED control (on/off/dimming) and Control System wall control.

new
20
21



* Also available the Upgrade kit for Motor Kit Plus for conversion into Motor Kit Advanced.

CHOOSE THE MODEL THAT SUITS YOU

Description	Power supply	Weight
Motor Kit Compact F80s	12 V	1,9 kg
Motor Kit Plus F80s		2,0 kg
Motor Kit Advanced F80s [New]		2,0 kg
Kit Upgrade Advanced F80s* [New]		0,3 kg

For more technical and commercial information, see page 161

MOTOR KIT FOR F45

Motor Kit 12 V for F45s and F45L awnings, equipped with Control System wall control. Always allows manual opening and closing in case of emergency. Available in 3 colours.



MOTOR KIT FOR F65



*Integrated version available that can be installed inside the awning roller, without increasing its length.

CHOOSE THE MODEL THAT SUITS YOU For more technical and commercial information, see page 161

Descrizione	Power supply	Weight
Motor Kit for F45s		
Motor Kit for F45L		
Motor Kit for F65s		
Motor Kit for F65L > 2018	12 V	2,6 kg
Motor Kit for F65L < 2018		
Integrated Motor Kit for F65s*		





RAFTER

Fabric tensioning rafter. Adjustable in length from 145 cm to 250 cm. Suitable for awnings F45, F80 and F65 with extension up to 250 cm and length 550 cm.



RAFTER PRO

Curved rafter, raises the canvas slightly, to tension it in the best way. Adjustable in length from 145 cm to 250 cm. Suitable for awnings F45, F80 and F65 with extension up to 250 cm and length 550 cm.



RAFTER CARAVANSTORE / XL

Suitable for CaravanStore awnings with extension 225 and 250 cm (XL version). Adjustable in length from minimum 150 cm to maximum 250 cm.



AWNING HANGERS KIT

Kit of 6 hooks that slide into the awning lead bar to hang small light objects. They are also suitable for awnings of other brands with 7 mm slot.



MAGICRAFTER

Rafter to give more stability to your awning. Fits to arm knuckles. For awnings of any brand from 250 to 400 cm in length.



MAGICRAFTER PRO

Rafter to give more stability to your awning. Fits to arm knuckles. The two vertical supports provide optimal tension of the fabric compared to the Magicrafter. Not recommended for use at high temperatures. For awnings of any brand from 350 to 450 cm in length.



AWNING PEGS KIT

Resistant screw-on pegs ideal for awnings, Privacy Room and mats. They can be screwed to the ground by hand, ideal for soft, sandy soils.



AWNING PLATE KIT

Ideal for fastening the lead bar legs to the ground, increasing resistance in case of wind. They are suitable for all types of Fiamma and Thule/Omnistor awning legs.



REPAIR PLUS KIT

Kit composed of 3 adhesive transparent PVC strips, for DIY repair in case the awning fabric gets cut.



PATIO-MAT

Essential mat for your awning, available in 5 different lengths. Made of polypropylene, it lets air filter; self-extinguishing and UV-resistant.

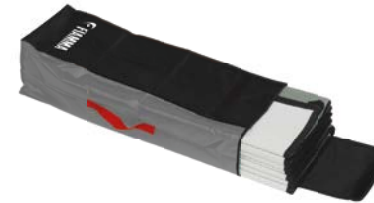

PATIO-BAG

To store your Patio-Mat conveniently.



CRANK HANDLE

Crank handle, available in 3 different lengths: Short, Standard and Telescopic.



SPOILER S

For a lower wind resistance of the awning Fiamma or other brands. Made of thermoformed ABS-PLUS with UV protection.



SAFETY STRIP

39 cm strip for F35pro, to close the lead bar with greater safety in rough tracks.



TIE DOWN

For anchoring wall or roof awnings to the ground. Consisting of an adjustable 11 m band, two pegs and a tension spring.



TIE DOWN S

For anchoring wall or roof awnings to the ground. Also ready to be hooked to the side of the Privacy Room. Tie Down S CaravanStore version suitable for CSe F35pro (with leg fastening). Composed of 2 adjustable 300 cm bands, 2 pegs, 2 tension springs and 2 front hooks.

Accessories

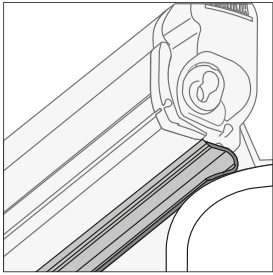

RAIN GUARD LOWER

For F45s/L and F70 awnings with suspended installation spaced from the wall. It can be installed on the slot of the case box.

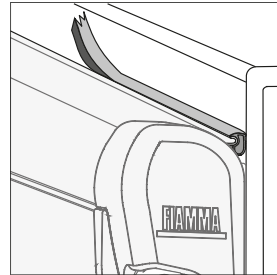

RAIN GUARD S

For awnings mounted with the AS 120 bracket on flat walls.

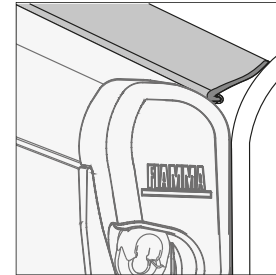

RAIN GUARD M

For awnings spaced up to 4 cm from the wall or on curved walls.

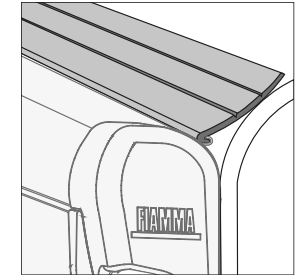

RAIN GUARD L

For awnings spaced up to 9 cm from the wall or on curved walls.

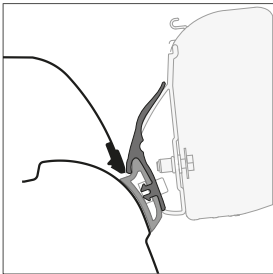

RAIN GUARD CALIFORNIA KIT

For F45s and F35pro awnings installed on VW California. Length 200 cm.

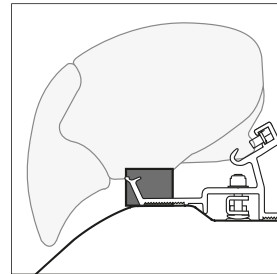

RAIN GUARD KIT F80 / F65

For roof awnings F80s, F65s and F65L, they cover the entire space between the roof and the awning. Available in two versions: 450 cm and 50 cm kits.

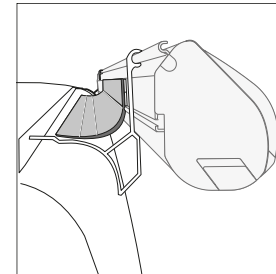

RAIN GUARD VAN KIT

For F45s and F35pro awnings with suspended installation on camper vans, spaced from the wall. Length 300 cm.

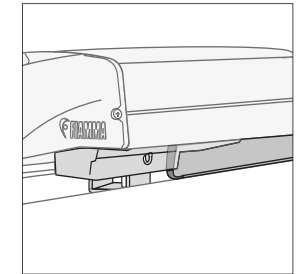

RAIN GUARD KIT F40 VAN

For F40van awnings. Length 270 cm.



Fiamma enclosures are designed to offer you all the privacy you need. Complete solutions with quick assembly, they create lots of extra space, shaded and bright, protected from the weather. The wide range of models allows you to choose the enclosures that best suits your needs.



FRONT AND SIDE PANELS

Single panels, quick and easy to install, provide privacy and protection, while maintaining access to the shaded area of the awning.



ENCLOSURES

Composed of front and two side panels, quick to install thanks to the Fast Clip system, they are light, elegant and have large windows, equipped with mosquito net and blinds. They are available for winch awnings and manual awnings.



COMPLETE AWNING WITH ENCLOSURE

Supplied complete with Privacy enclosure and awning which, thanks to the strong zippers, turns into a complete enclosure in just a few minutes.



REAR DOOR ENCLOSURES

Specific for the back of camper vans and van conversions, ideal to increase your privacy in a few simple steps.



SKIRTING FOR WIND PROTECTION

Suitable for various types of vehicles, they provide protection and eliminate draughts.

ENCLOSURES

**Create your own private,
safe and comfortable space**



Blocker

Front panels that allow you to conveniently arrange access to the shaded area of the awning.

- quick installation
- They are also suitable for awnings of other brands
- Crystal full light window



Front panels

- Sun protection
- Rain protection
- Wind protection

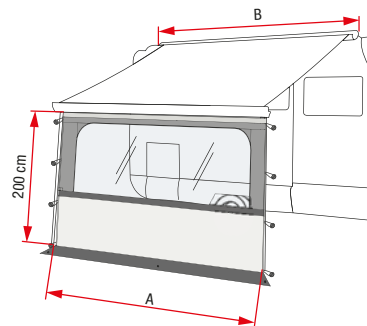

BLOCKER PRO



Front panel with a large Crystal full light window, with grey vinyl extension to the ground. Made of rot-proof, washable and easy to assemble vinyl fabric with UV protection.

Complete with:

- elastics hooks and pegs for fastening

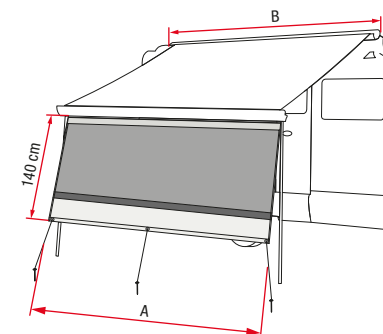

BLOCKER



Convenient front panel that protects you from sun light and rain and gives you more privacy.

Supplied with:

- ropes and pegs for fastening

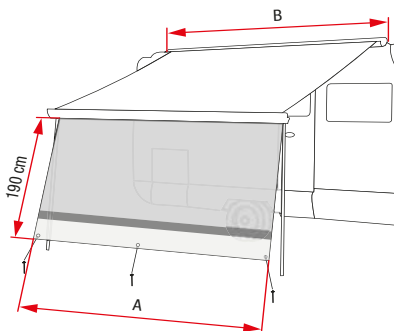

SUN VIEW XL



Comfortable front panel. Made of translucent light filtering fabric, which partially blocks out light. It can be rolled up with convenient fixing clips.

Supplied with:

- ropes and pegs for fastening

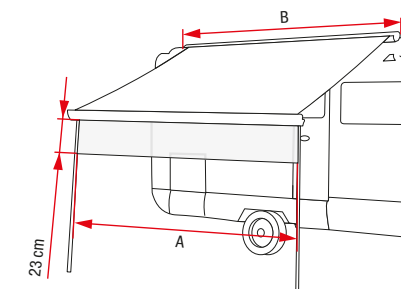

SHADE SUN VIEW



The Shade Sun View valance with translucent light filtering material protects from sun and rain extending the shade surface. Suitable for all awning models, single length 550 cm easily adjustable to the length of the awning.

☰ CHOOSE THE MODEL THAT SUITS YOU

For more technical and commercial information, see page 162

	A	B	Weight
Blocker Pro 100	± 100 cm	from 250 cm	0,8 kg
Blocker Pro 250	± 235 cm	from 250 cm	2,7 kg
Blocker Pro 260 Van	± 250 cm	from 260 cm	2,7 kg
Blocker Pro 280	± 255 cm	from 270 cm	3,0 kg
Blocker Pro 300	± 285 cm	from 300 cm	3,2 kg
Blocker Pro 350	± 335 cm	from 340 cm	3,8 kg
Blocker Pro 375	± 360 cm	from 370 cm	4,1 kg
Blocker Pro 400	± 385 cm	from 400 cm	4,5 kg
Blocker Pro 425	± 410 cm	from 425 cm	4,7 kg
Blocker Pro 440	± 415 cm	from 440 cm	4,9 kg
Blocker Pro 450	± 435 cm	from 450 cm	5,0 kg
Blocker Pro 500	± 463 cm	from 500 cm	5,5 kg
Blocker Pro 550	± 513 cm	from 550 cm	6,0 kg

	A	B	Weight
Sun View XL 100	± 100 cm	from 250 cm	0,5 kg
Sun View XL 260	± 250 cm	from 250 cm	1,9 kg
Sun View XL 300	± 285 cm	from 300 cm	2,1 kg
Sun View XL 350	± 335 cm	from 340 cm	2,3 kg
Sun View XL 375	± 360 cm	from 370 cm	2,4 kg
Sun View XL 400	± 385 cm	from 400 cm	2,5 kg
Sun View XL 425	± 410 cm	from 425 cm	2,6 kg
Sun View XL 450	± 435 cm	from 450 cm	2,7 kg
Sun View XL 500	± 465 cm	from 500 cm	2,9 kg
Sun View XL 550	± 513 cm	from 550 cm	3,1 kg

	A	B	Weight
Shade Sun View	± 550 cm	from 190 cm	0,5 kg

	A	B	Weight
Blocker 260	± 253 cm	from 260 cm	2,3 kg
Blocker 300	± 85 cm	from 300 cm	2,6 kg
Blocker 350	± 335 cm	from 340 cm	2,9 kg
Blocker 400	± 385 cm	from 400 cm	3,3 kg
Blocker450	± 438 cm	from 450 cm	4,0 kg

☰ ACCESSORIES



MEGA BAG

Large, strong bag for storing the front and side panels of the Blocker and Side range or any other accessory you want to protect. Available in two sizes.

For more technical and commercial information, see page 161



Side

Side panels that give you privacy and provide greater protection from wind, rain and sun.

- quick installation
- They are also suitable for awnings of other brands
- Crystal full light windows



Side panels

- Sun protection
- Rain protection
- Wind protection

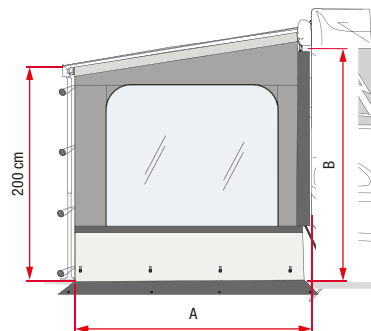

SIDE W PRO



Side panel with large Crystal full light window and grey extension to the ground, made of rot-proof, UV-resistant and washable vinyl.

Complete with:

- aluminium rafter
- pegs

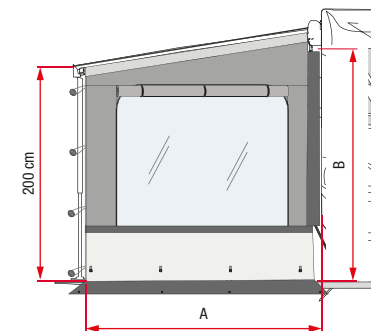

SIDE W PRO SHADE



Side enclosure with large Crystal full light window, roller blind and grey extension to the ground, made of rot-proof, UV-resistant and washable vinyl.

Complete with:

- aluminium rafter
- pegs

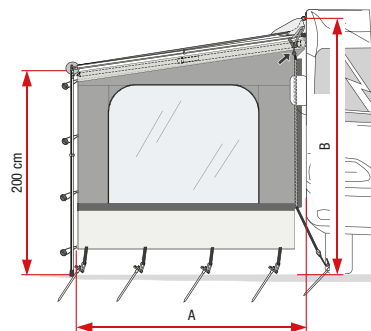

SIDE W CARAVANSTORE



Side panel with large Crystal full light window made of rot-proof, UV-resistant and washable vinyl.

Complete with:

- aluminium rafter
- pegs

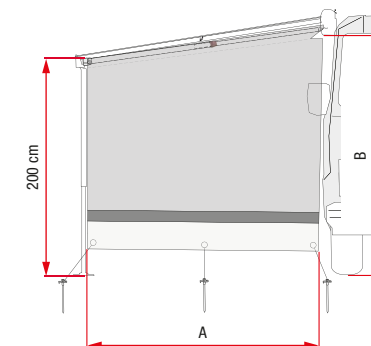

SUN VIEW SIDE



Side panel made of translucent light filtering fabric, which partially blocks out light.

Complete with:

- aluminium rafter
- tension ropes and pegs

CHOOSE THE MODEL THAT SUITS YOU

	A	B	Weight
Side W Pro F45 / F65 / F80	230 cm	225-280 cm	4,2 kg
Side W Pro XXL F45 / F65 / F80	230 cm	280-330 cm	4,5 kg
Side W Pro Van F45	190 cm	180-200 cm	3,4 kg
Side W Pro F65 / F80 Ducato	230 cm	225-280 cm	4,2 kg
Side W Pro F40van	210 cm	180-210 cm	3,0 kg
Side W Pro CaravanStore / F35	210 cm	240-260 cm	4,5 kg
Side W Pro CaravanStore XL	240 cm	240-260 cm	4,8 kg
Side W Pro F35 Van	210 cm	180-220 cm	4,2 kg

	A	B	Weight
Side W Pro Shade F45 / F65 right	230 cm	225-280 cm	5,3 kg
Side W Pro Shade F45 / F65 left	230 cm	225-280 cm	5,3 kg

	A	B	Weight
Side W CaravanStore / F35	210 cm	240-260 cm	3,9 kg
Side W CaravanStore XL	240 cm	240-260 cm	4,2 kg

	A	B	Weight
Sun View Side F45 / F65 / F80	230 cm	220-260 cm	1,4 kg
Sun View Side CaravanStore/F35	210 cm	180-260 cm	1,3 kg
Sun View Side CaravanStore XL	240 cm	180-260 cm	1,6 kg

For more technical and commercial information, see page 163

ACCESSORIES



For more technical and commercial information, see page 161

MEGA BAG

Large, strong bag for storing the front and side panels of the Blocker and Side range or any other accessory you want to protect. Available in two sizes.



Privacy Room



- F45s
- F45L
- F65L
- F80s

Recommended season



Installation speed

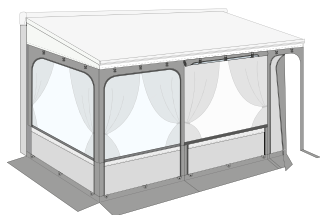

Privacy Room Light / CS Light



- F45s (P.R. Light)
- F80s (P.R. Light)
- F35pro (P.R. CS Light)
- CaravanStore (P.R. CS Light)
- CaravanStore XL (P.R. CS Light XL)

Recommended season



Installation speed

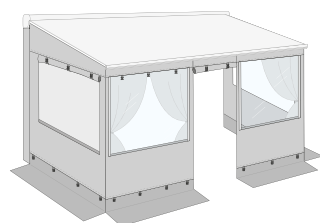

Privacy Ultra Light



- F45s
- F45L
- F65L
- F80s

Recommended season



Installation speed

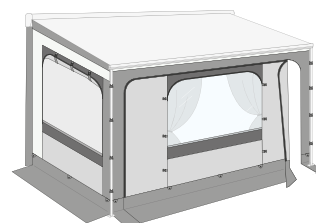

Room Van / Premium



- F40van

Recommended season



Installation speed

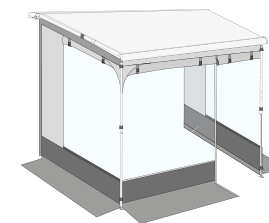





Privacy Room

Privacy Room

Classic enclosure suitable for all seasons, the best solution for medium and long term stays.

- quick installation in 15 minutes with Fast Clip poles
- ideal for all seasons
- composed of one front panel and two side panels
- all Crystal full light windows that can be rolled up, with mosquito net and curtains as standard
- 3 heights are available: Van [S], Medium [M], Large [L]
- standard pegs for safe anchoring
- complete with Mega Bag to store Privacy Room and poles



01 Panels
With roll-up Crystal full light window, fitted with mosquito net and curtains as standard

02 Additional front panels
With fixed Crystal full light window and curtains as standard equipment

03 Windows
Equipped with a thick velcro strip for a safe closing of the window

04 Fast Clip
For quick and safe hooking to the awning fabric with internal lever hooks

06 Fabric
Waterproof and UV-resistant, rot-proof and washable vinyl

07 Door
It can be positioned on the left side of the front panel and easily moved to the right side of the same

05 Zippers
Join the front and side panels

Mega Bag
Delivered as standard.
Dimensions 140x27x40 cm.

08 Protective sponge
Positioned vertically at the rear of the side panels

09 Rafter
Telescopic aluminium as standard (2 pieces) to lock the protective sponge

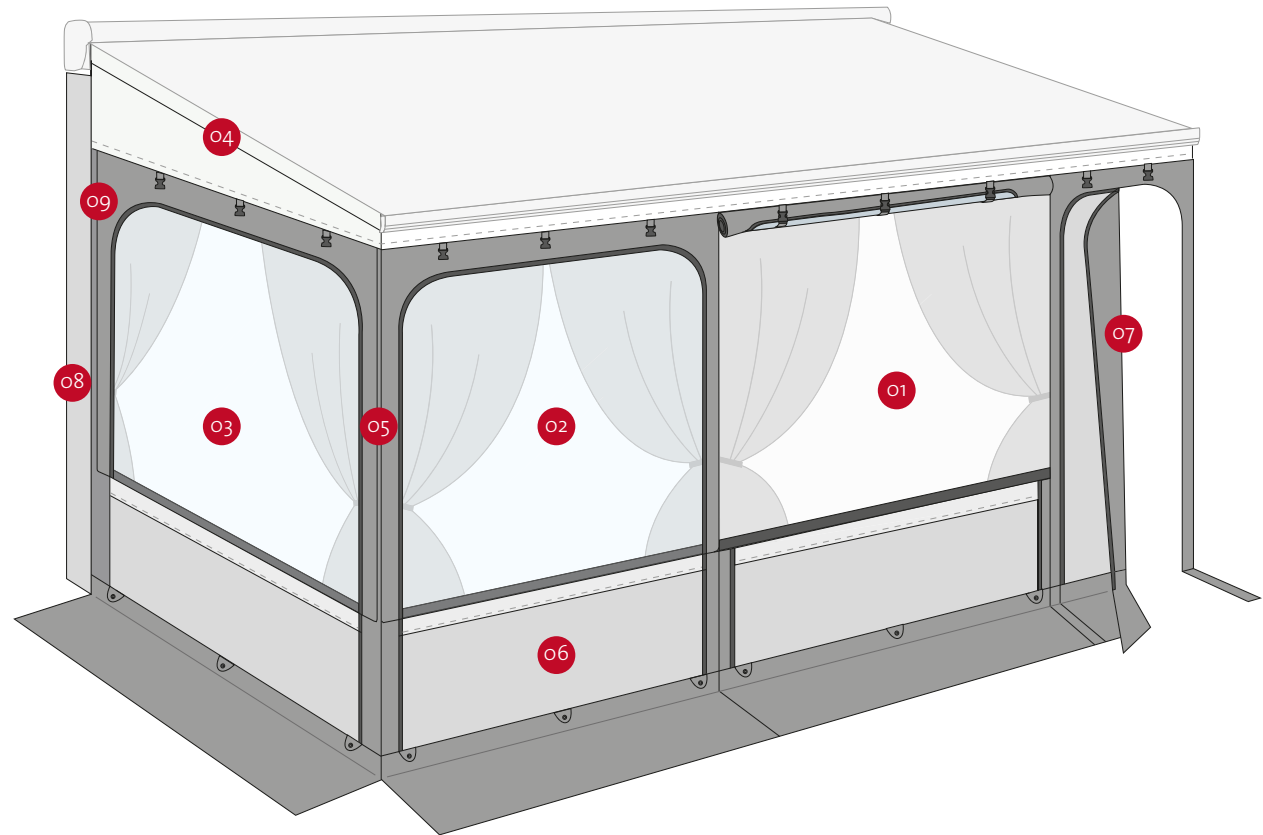

+ ADD TO YOUR PRIVACY ROOM

Accessories

- Tie Down S
- Curtains Kit Smoke
- Pack Organizer
- Pack Organizer Privacy
- Privacy Kit Rail
- Skirting
- Rain Caps F45
- Door Pole
- Kit Magic Privacy Front
- Kit Magic Privacy Side

III FOR FIAMMA AWNINGS F45s, F45L

For more technical and commercial information, see page 164

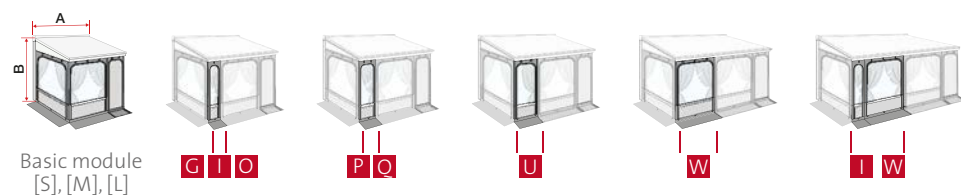

A	B	Composition	
260 cm	Van [S]	Basic module	[S]
300 cm	180-220 cm	Basic module + panel 40	[S] + G
300 cm		Modulo base	[M] / [L]
350 cm		Basic module + panel 50	[M] / [L] + I
375 cm	Medium [M]	Basic module + panel 75	[M] / [L] + O
400 cm	225-250 cm	Basic module + panel 100	[M] / [L] + P
425 cm	Large [L]	Basic module + panel 125	[M] / [L] + Q
450 cm	251-280 cm	Basic module + panel 150	[M] / [L] + U
500 cm		Basic module + panel 200	[M] / [L] + W
550 cm		Basic module + panels 200 + 50	[M] / [L] + W + I

III FOR FIAMMA AWNINGS F80s, F65L

For more technical and commercial information, see page 164

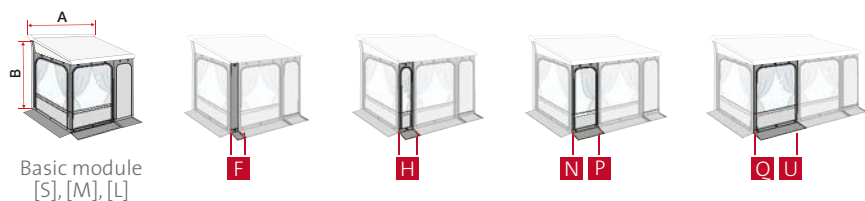

A	B	Composition	
300 cm		Basic module	[S] / [M] / [L]
320 cm	Van [S]	Basic module + panel 20	[S] / [M] / [L] + F
340 cm	245 cm	Basic module + panel 40	[S] / [M] / [L] + H
370 cm	Medium [M]	Basic module + panel 70	[S] / [M] / [L] + N
400 cm	245-280 cm	Basic module + panel 100	[S] / [M] / [L] + P
425 cm	Large [L]	Basic module + panel 125	[S] / [M] / [L] + Q
450 cm	280 cm	Basic module + panel 150	[S] / [M] / [L] + U





P. Room Light



P. Room CS Light/XL

Privacy Room Light / CS Light

Light and compact enclosure, suitable for summer or mid-season.

- quick installation in 15 minutes with Fast Clip CS poles
- ideal for summer or mid-season
- Crystal full light front window that can be rolled up, with mosquito net and curtains as standard
- 3 heights available for F45 version: Van [S], Medium [M], Large [L]
- 2 heights available for the CaravanStore version : Van [S], Medium [M]
- pegs and elastic ropes with hooks as standard for secure anchoring
- complete with Mega Bag to store Privacy Room and poles

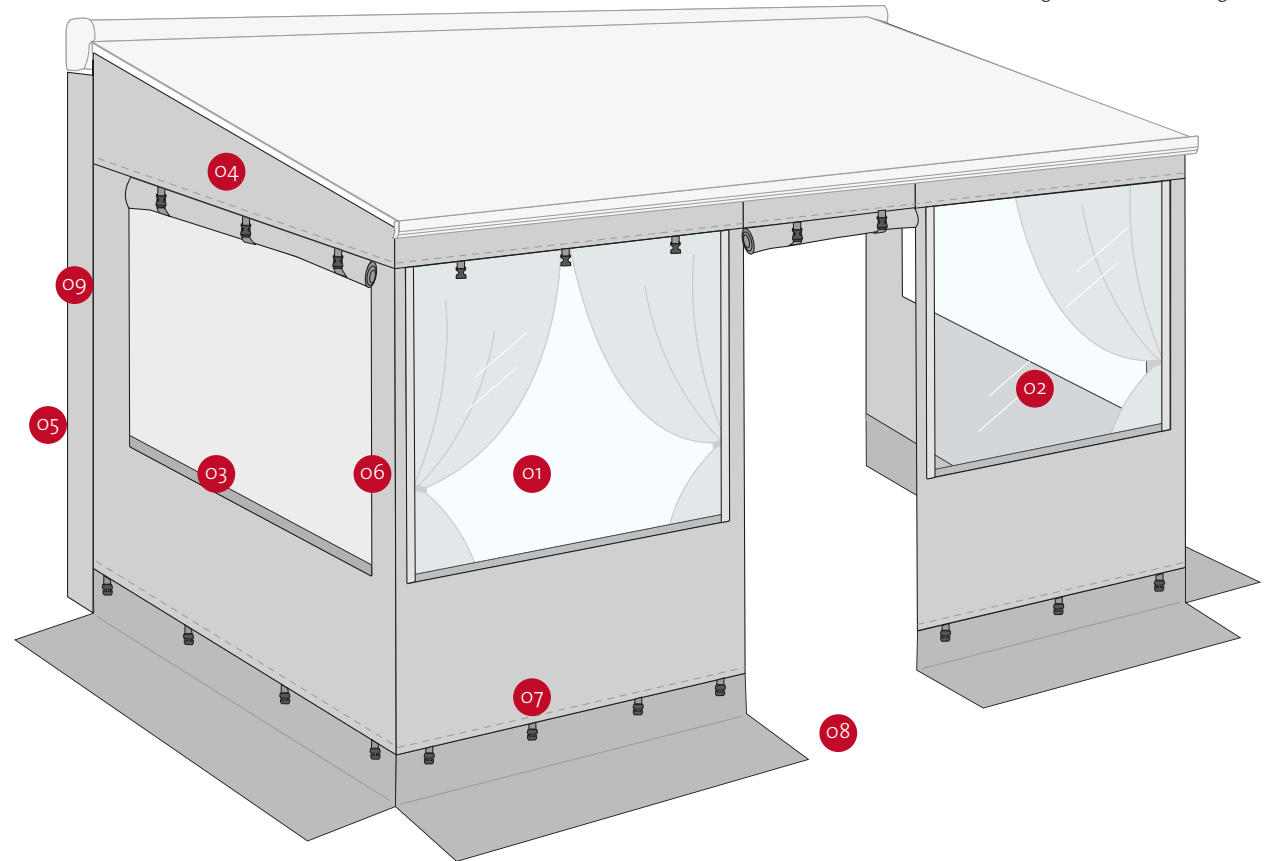

01 Front panel
With roll-up Crystal full light window, fitted with mosquito net and curtains as standard

02 Additional panels
With fixed Crystal full light window and standard curtains, or fixed blinds

03 Side panels
With roll-up blind and mosquito net

04 Fast Clip CS
For quick and safe hooking to the awning fabric with internal lever hooks

05 Easy installation
The side panels stick to the wall of the vehicle with the elastic ropes that are delivered as standard and are provided with quick hooks.

+ ADD TO YOUR PRIVACY ROOM

Accessories

- Tie Down S
- Curtains Smoke Kit
- Skirting
- Rain Caps F45s
- Poles Light kit
- Door Pole
- Kit Magic Privacy Front / Side

06 Zippers
Join the front and side panels

07 Fabric
Lightweight and durable polyester

08 Door
It can be positioned on the left side of the front panel and easily moved to the right side of the same

09 Rafter
Telescopic aluminium (optional) to lock the protective sponge

■ FOR FIAMMA AWNINGS F45S AND F45L

For more technical and commercial information, see page 165

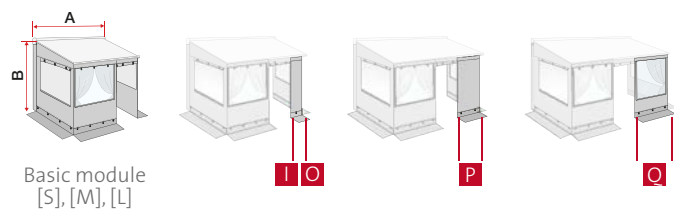
Basic module
[S], [M], [L]

A	B	Composition	
260 cm	[S] 180-220 cm	Basic module	[S]
300 cm		Basic module	[M] / [L]
350 cm	[M] 225-250 cm	Basic module + panel 50	[M] / [L] + I
375 cm		Basic module + panel 75	[M] / [L] + O
400 cm	[L] 251-280 cm	Basic module + panel 100	[M] / [L] + P
425 cm		Basic module + panel 125	[M] / [L] + Q

■ FOR FIAMMA AWNINGS CS AND F35PRO

For more technical and commercial information, see page 165

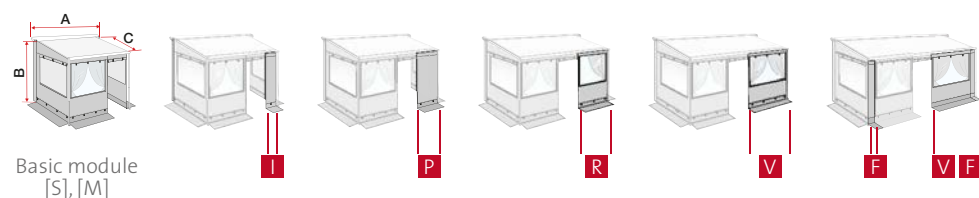
Basic module
[S], [M]

A	Suitable for	B	C	Composition		
250 cm	F35pro	180-220 cm		P. Room CS Light 250 Van		
270 cm	F35pro		225 cm	P. Room CS Light 270 Van		
280 cm	CS + F35pro			P. Room CS Light 280		
310 cm	CS + F35pro			Basic module	[S] / [M]	
360 cm	CStore	240-260 cm	[S] 225 cm	Basic module + panel 50	[S] / [M] + I	
410 cm	CStore			Basic module + panel 100	[S] / [M] + P	
440 cm	CStore		[M] 250 cm		Basic module + panel 130	[S] / [M] + R
500 cm	CStore				Basic module + panel 190	[S] / [M] + V
550 cm	CStore				Basic module + panels 190 + 20 (2x)	[S] / [M] + F + V + F





Privacy Ultra Light

Privacy Ultra Light

Enclosure made in one piece with double ventilated roof. Quick to install, it is ideal for short stays or weekends.

- quick installation in 5 minutes
- ideal for warm seasons
- made in one piece
- double roof composed of awning cover and Privacy roof
- removable front
- transverse rafters and pegs for safe anchoring
- complete with Mega Bag to store Privacy Room and poles

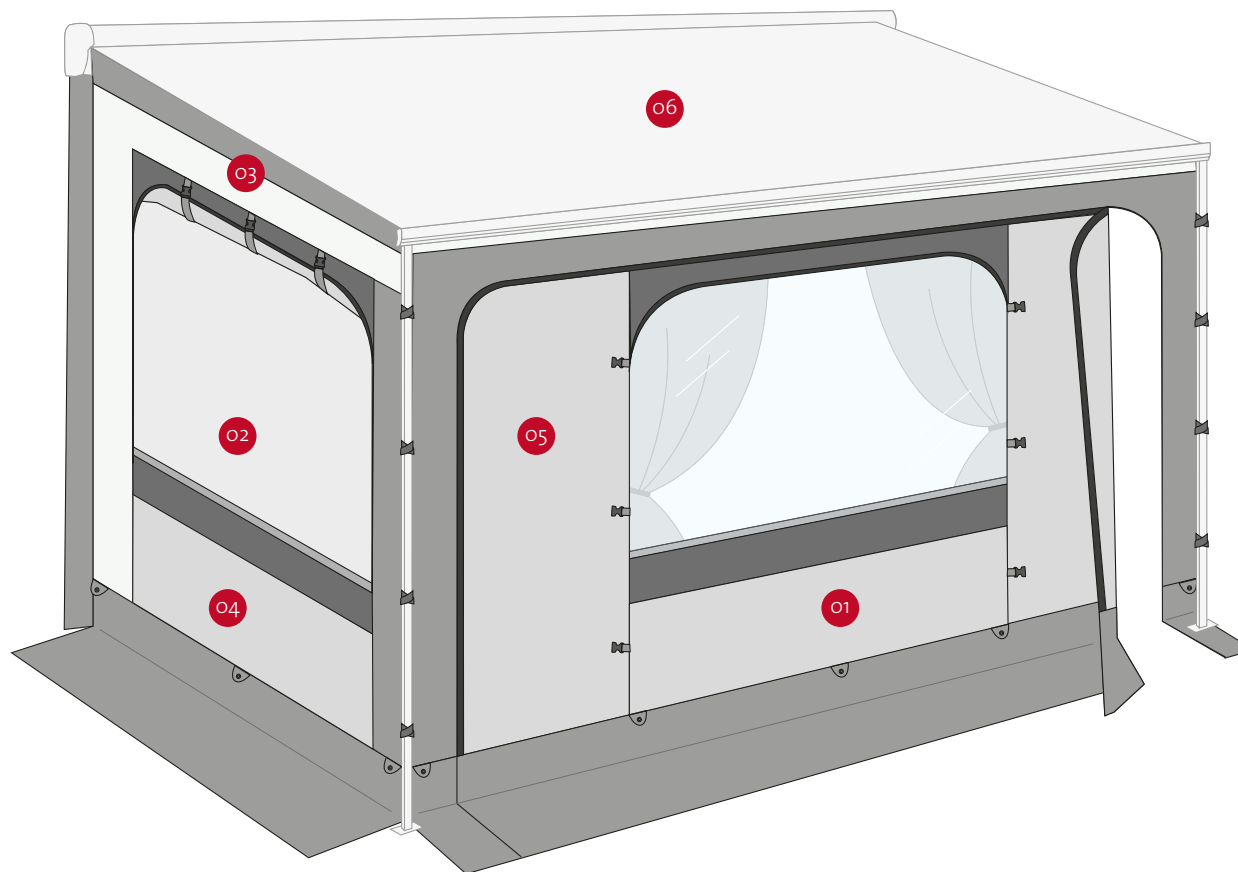

01 Front panel

Removable, equipped with Crystal full light window with standard curtains and door

02 Side panels

With roll-up blind and mosquito net

03 One single piece

Made in one piece consisting of roof, sides and fronts

Mega Bag

Delivered as standard.
Dimensions 140x25x25 cm.

+ ADD TO YOUR PRIVACY ROOM

Accessories

- Tie Down S
- Curtains Kit Smoke
- Skirting
- Door Pole F45
- Kit Poles

04 Opening sides

Possibility to open them increasing the shaded area

05 Fabric

Ripstop, lightweight and tear-resistant

06 Double roof

Composed of the awning fabric and the Privacy roof which create an air chamber with constant ventilation thus lowering the temperature inside the Privacy room

 FOR FIAMMA AWNINGS F45, F65, F80

For more technical and commercial information, see page 166

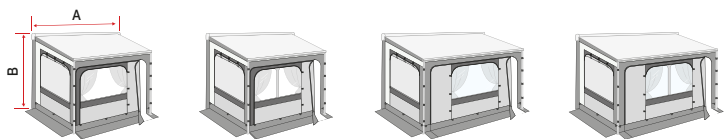
P.R. Ultra Light Van 260
P.R. Ultra Light 300P.R.
Ultra Light 350P.R.
Ultra Light 400P.R.
Ultra Light 450

Privacy Room	A	B	Weight
Privacy Ultra Light Van 260	260 cm	180-220 cm	12,3 kg
Privacy Ultra Light 300	300 cm	230-280 cm	14,2 kg
	320 cm		
Privacy Ultra Light 350	350 cm	230-280 cm	15,4 kg
	370 cm		
Privacy Ultra Light 400	400 cm		16,6 kg
Privacy Ultra Light 450	450 cm		17,8 kg





Room Van / Premium

Room Van

Specific enclosure for F40van.
Without poles, it is quick to install and ideal for those who like to move on quickly.

- quick installation in 5 minutes
- light and without poles
- roof, front and side in one piece
- complete with Mega Bag
- available in 2 versions: Room Van Premium and Room Van

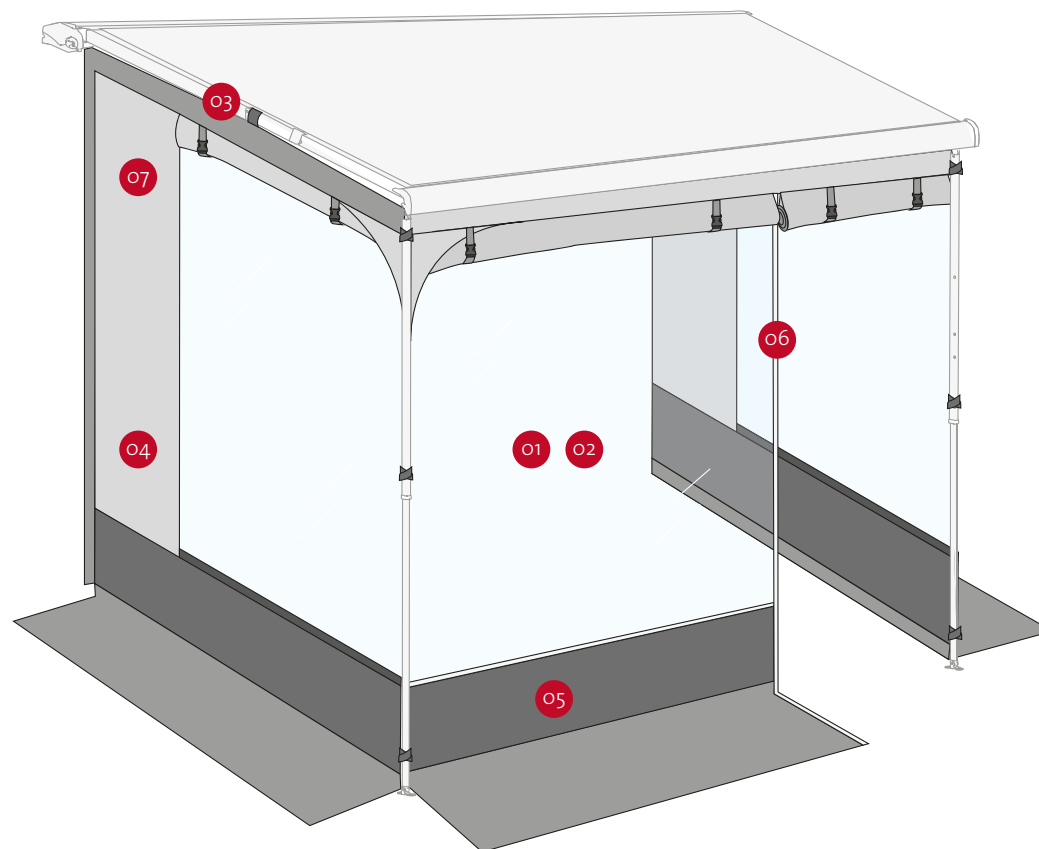

01 Room Van Premium

Roll-up door, Crystal full light front panel and roll-up blind, side panels with mosquito nets and roll-up blinds

02 Room Van

Blind side panels and Crystal full light front panel with roll-up blind

03 Fixing

No poles, direct fixing to the case box and the lead bar of the awning

04 One single piece

Made in one piece consisting of roof, sides and fronts

05 Fabric

Ripstop, lightweight and tear-resistant

06 Opening front panel

Completely openable by increasing the shaded area (with optional Poles Kit)

07 Compact

Takes up little storage space in the Mega Bag provided

+ ADD TO YOUR PRIVACY ROOM

Accessories

- Kit Poles
- Skirting VW T5/T6

 FOR THE AWNING FIAMMA F40VAN

For more technical and commercial information, see page 166

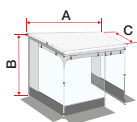

Room Van Premium

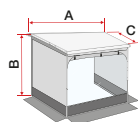

Room Van

	A	B	C	Weight
Room Van Premium	270 cm	180-210 cm	225 cm	5,4 kg
Room Van	270 cm	180-210 cm	225 cm	4,8 kg





Fiamma ZIP

Fiamma ZIP

Complete awning with enclosure composed of awning on F45 base and front and side panels joined to the awning fabric thanks to strong zippers.

- awning on F45 base with installation brackets included
- privacy enclosure: front and side panels
- zipper hinge system
- Crystal full light windows that can be rolled up, with mosquito net and curtains as standard
- rapid Set and tension rafter installation kit
- complete with windproof Skirting enclosure
- elastic ropes with quick hooks as standard
- complete with Mega Bag to store Privacy Room and poles
- 2 heights available: Medium [M], Large [L]

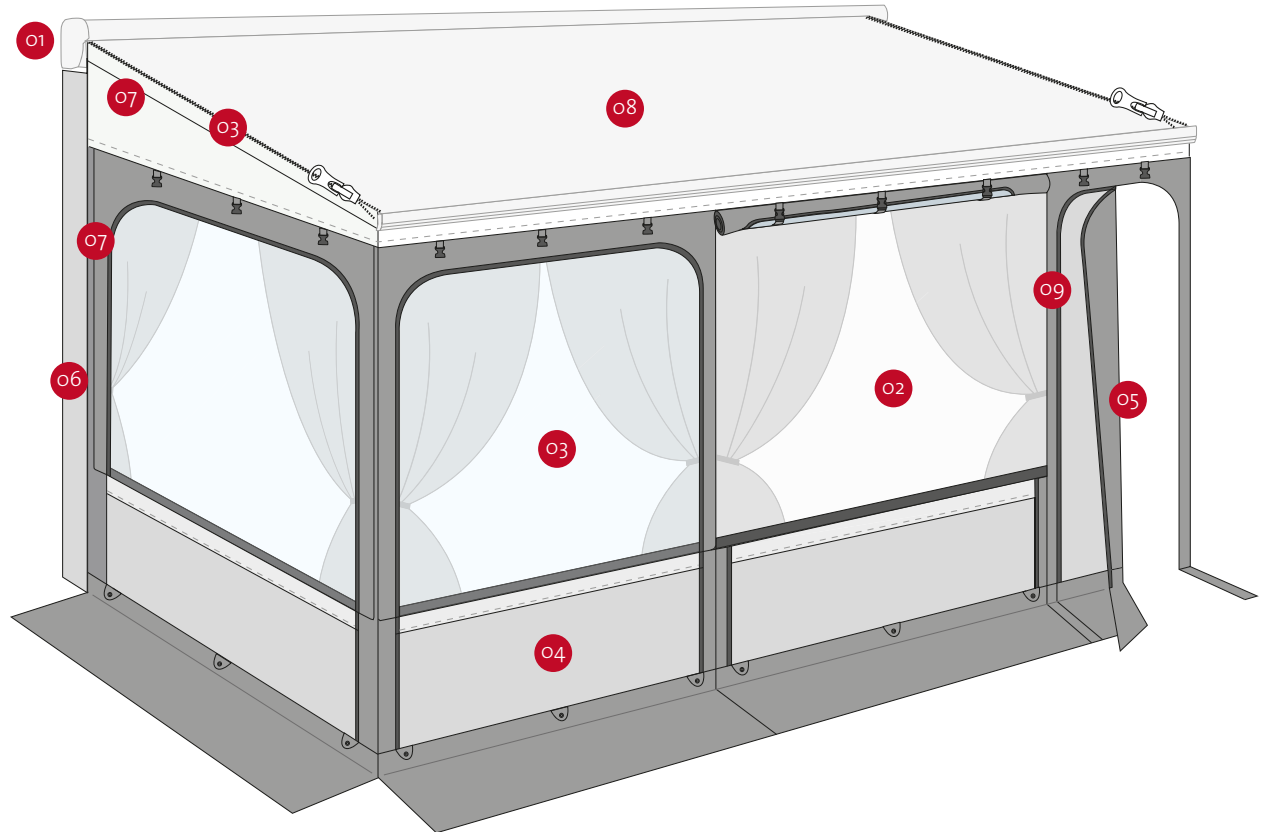

01 Awning
Base F45 Polar White, with installation brackets included

02 Panels
With roll-up Crystal full light window, fitted with mosquito net and curtains as standard

03 Zippers
Combine Privacy with the awning fabric

04 Fabric
Waterproof and UV-resistant, rot-proof and washable vinyl

Mega Bag
Delivered as standard. Dimensions 140x27x40 cm.

+ ADD TO YOUR FIAMMA ZIP

Accessories

- Tie Down S
- Curtains Kit Smoke
- Pack Organizer / Privacy
- Privacy Kit Rail
- Rain Caps F45
- Door Pole
- Kit Magic Privacy Front / Side

05 Door
It can be positioned on the left side of the front panel and easily moved to the right side of the same

06 Protective sponge
Positioned vertically at the rear of the side panels towards the vehicle

07 Rapid Set
Composed of 2 + 2 aluminium poles for the installation of the Privacy system

08 Rafter
Length-adjustable fabric tension rod

09 Door Pole
Standard for the Fiamma ZIP 450, to increase the stability of the door

 MODELS AND DIMENSIONS

For more technical and commercial information, see page 166

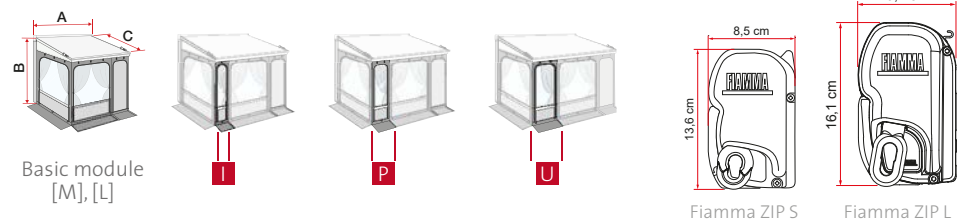
Basic module
[M], [L]

Fiamma ZIP S

Fiamma ZIP L

Description	Awning	A	B	C	
Fiamma ZIP S 300 Medium		306 cm			[M]
Fiamma ZIP S 350 Medium	F45s	356 cm	[M] Medium 225-250 cm		[M] + I
Fiamma ZIP L 400 Medium		406 cm			[M] + P
Fiamma ZIP L 450 Medium	F45L	456 cm			[M] + U
Fiamma ZIP S 300 Large		306 cm		250 cm	[L]
Fiamma ZIP S 350 Large	F45s	356 cm	[L] Large 251-280 cm		[L] + I
Fiamma ZIP L 400 Large		406 cm			[L] + P
Fiamma ZIP L 450 Large	F45L	456 cm			[L] + U





CStore ZIP XL

CaravanStore ZIP XL

Complete awning with enclosure composed of awning based on CaravanStore, with front and side panels joined to the awning fabric thanks to strong zippers.

- awning on CaravanStore base
- privacy enclosure: front and side panels
- zipper hinge system
- Crystal full light windows that can be rolled up, with mosquito net and curtains as standard
- rapid Set and CS installation kit
- elastic ropes with quick hooks as standard
- complete with Mega Bag to store Privacy Room and poles



01 Awning
CaravanStore base with grey bag

02 Panels
With roll-up Crystal full light window, fitted with mosquito net and curtains as standard

03 Windows
Equipped with a thick velcro strip for a safe closing of the window

04 Zippers
Combine Privacy with the awning fabric

07 Flexyblock
System that reinforces the tension of the rafter thanks to the extension 250 cm

08 Support poles
CaravanStore Support Leg (length 3.60 m) and Rafter CaravanStore (length 4.0 m) for fabric tensioning

05 Fabric
Waterproof and UV-resistant, rot-proof and washable vinyl

09 Rapid Set CS
Composed of 2 + 2 aluminium poles for the installation of the Privacy system

06 Door
It can be positioned on the left side of the front panel and easily moved to the right side of the same

10 Easy installation
The side panels stick to the wall of the vehicle with the elastic ropes that are delivered as standard and are provided with quick hooks.

+ ADD TO YOUR CARAVANSTORE ZIP

Accessories

- Tie Down S CaravanStore
- Curtains Kit Smoke
- Pack Organizer
- Pack Organizer Privacy
- Privacy Kit Rail
- Skirting Caravan
- Door Pole
- Kit Magic Privacy Front
- Kit Magic Privacy Side

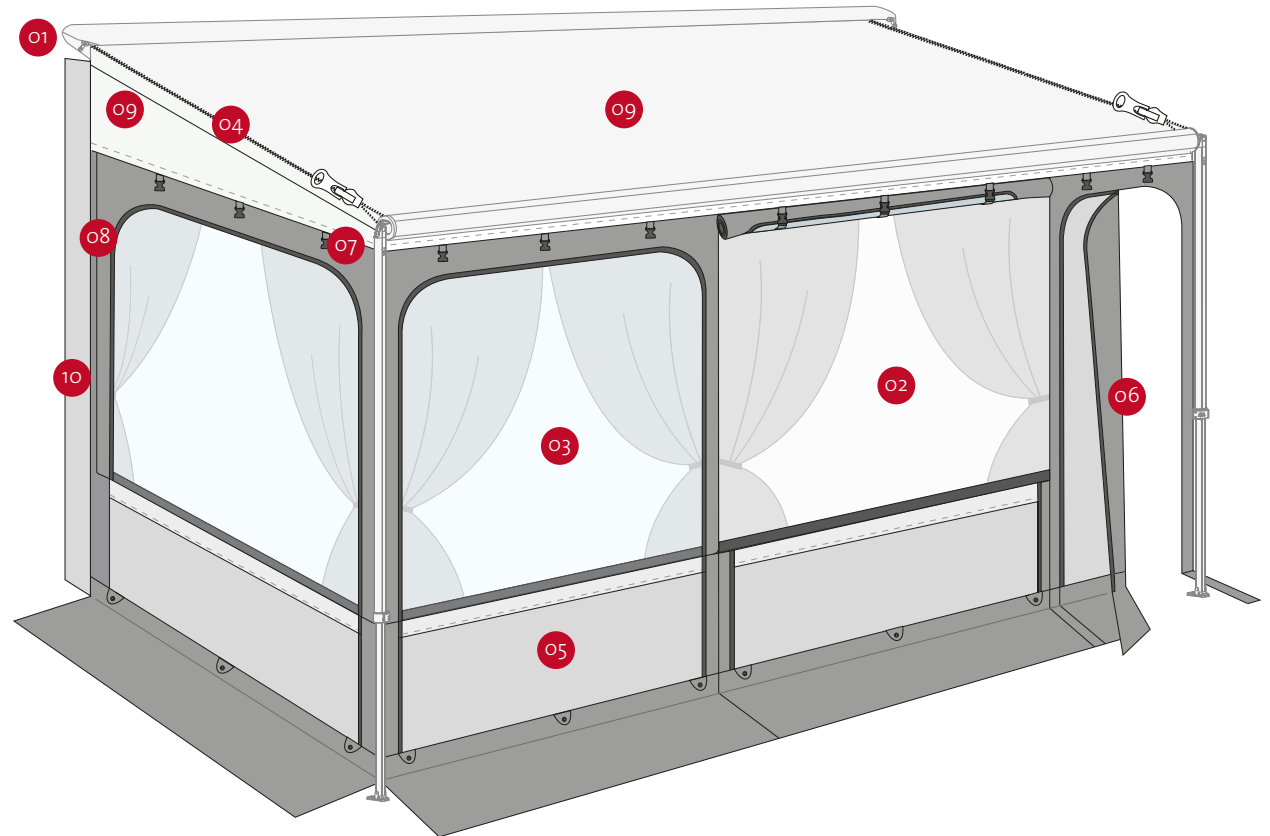

MODELS AND DIMENSIONS

For more technical and commercial information, see page 167

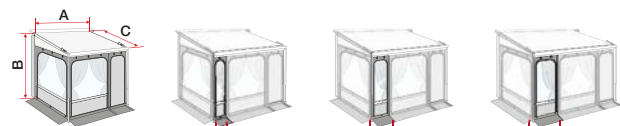

Basic module
[D], [E]

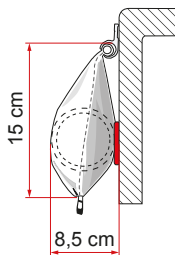
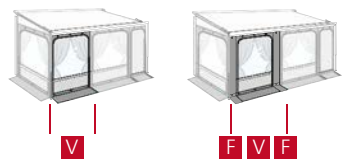

Description	Awning	A	B	C	
CaravanStore ZIP XL 280		288 cm			[D]
CaravanStore ZIP XL 310		318 cm			[E]
CaravanStore ZIP XL 360		369 cm			[E] + I
CaravanStore ZIP XL 410	CS XL	419 cm	240-260 cm	250 cm	[E] + P
CaravanStore ZIP XL 440		449 cm			[E] + R
CaravanStore ZIP XL 500		509 cm			[E] + V
CaravanStore ZIP XL 550		559 cm			[E] + F (x2) + V



Rear Door Cover

Enclosures for rear doors of campervans and van conversions with double doors

- quick installation
- to make the most of the space



Rear Door Cover

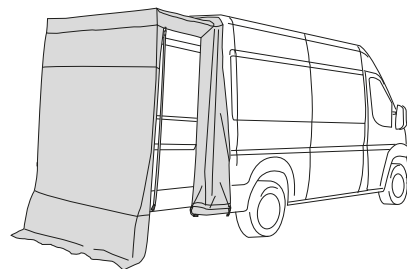

REAR DOOR COVER DUCATO

With side belts and roll-up front enclosure. Suitable for Fiat Ducato, Citroën Jumper and Peugeot Boxer H2 after 2006 and Mercedes Sprinter H2 from 2006 to 2008. Complete with rafter, pegs and tension elastics.

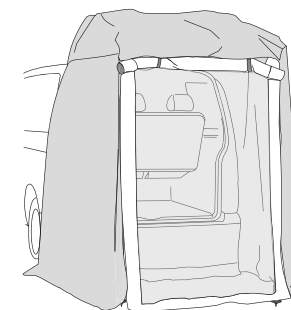

REAR DOOR COVER VW T5/T6

Quickly installation on standard hatches or with Carry-Bike installed (with no bikes). Roll-up or extendable door and mosquito net. Complete with floor poles, pegs, tension elastics and Mega Bag Light.

CHOOSE THE MODEL THAT SUITS YOU

	Weight
Rear Door Cover Ducato	3.3 kg
Rear Door Cover VW T5/T6	9.8 kg

For more technical and commercial information, see page 167

ACCESSORIES



POLES KIT

Set of two aluminium poles to extend the door as an additional awning.

For more technical and commercial information, see page 167

Skirting

Protection against wind that eliminates draught.

- can be shortened to awning size
- different models for each type of vehicle



Skirting

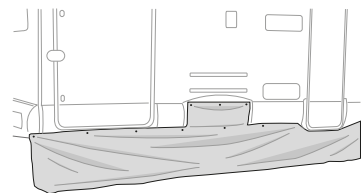

SKIRTING MOTORHOME

Complete with snap fastener kit.

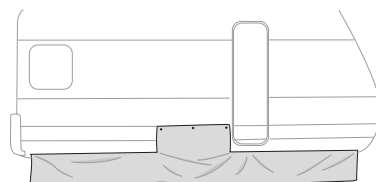

SKIRTING CARAVAN

Slides into the vehicle's standard rail.

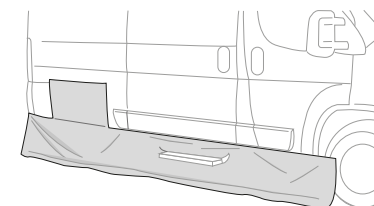

SKIRTING DUCATO

Complete with wheel cover, elastic belts and magnets. Suitable for wheelbases length L2, L3, L4.

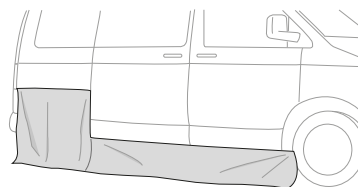

SKIRTING VW T5/T6

Complete with wheel cover, elastic belts and magnets.

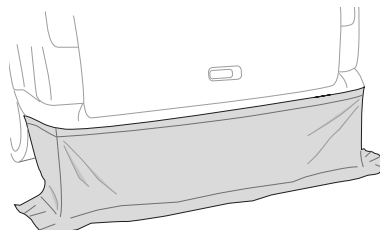

REAR SKIRTING VW T5 / T6

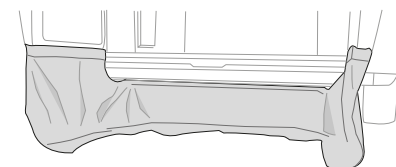

REAR SKIRTING DUCATO

CHOOSE THE MODEL THAT SUITS YOU

	Dimensions	Weight		Weight
Skirting Motorhome	550x60h cm	1.7 kg	Rear Skirting Ducato	1.7 kg
Skirting Caravan	450x60h cm	1.8 kg	Rear Skirting VW T5/T6	1.1 kg
Skirting Ducato	250x42h cm	1.4 kg		
Skirting VW T5/T6	497x45h cm	0.7 kg		

For more technical and commercial information, see page 167

Accessories



PATIO-MAT

Essential mat to increase your privacy, available in 5 different lengths. Made of polypropylene, it lets air filter; self-extinguishing and UV-resistant.

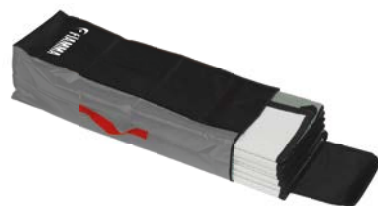

PATIO-BAG

To store your Patio-Mat conveniently.



MAGIC PRIVACY KIT

To increase the stability of the panels of the Privacy room in case of wind. Three versions available according to the length for the front panel, and one for the side panel.



DOOR POLE

Vertical telescopic pole in anodized aluminium for the front panel of the Privacy Room to increase stability when the door is kept open.



MOSKITO NET DOOR

Door with mosquito net, suitable for Privacy Room, Fiamma ZIP and CaravanStore ZIP XL.



RAIN CAPS

Pair of seals to prevent water infiltration into the Privacy Room when it is raining. To be applied on the awning side caps, suitable for F45s, F45L, Fiamma ZIP S and Fiamma ZIP L.



MEGA BAG

For storing front and side panels and Privacy Room.
Two versions available:
Mega Bag Elite 150x27x40 cm
Mega Bag Smart 150x25x25 cm



PRIVACY ORGANIZER PACK

Storage container to arrange everything and optimize the space inside the Privacy Room.



POLES KIT

Set of two aluminium poles to extend the door or the side panel as an additional awning, suitable for Privacy Ultra Light, Rear Door Cover Ducato and VW T5/T6.



POLES LIGHT KIT

Vertical support poles to increase the stability of the Privacy Room to the vehicles' wall. Optional for Privacy Room Light and Privacy Room CS Light.



PRIVACY RAIL KIT

Kit of 4 rails, 100 cm. each, for the installation of Pack Organizer S, L and Shoes inside the Privacy Room.



CURTAINS SMOKE KIT

Curtains for front and side panels of the Privacy Room and Blocker Pro front panels. Two kits available: 2 and 6 pieces.



For more technical and commercial information, see pages 160-161



MOTORHOME

The installation takes place on the rear wall of the vehicle, without compromising the rear view.



CARAVAN

Mounted on the A-frame or rear wall, your bikes are always safe.



CAMPERVAN

Thanks to specific models, your campervan can transport your bikes on the road.



VAN CONVERSIONS

You can mount your bike carrier even if you have a double rear door.



SUV

On the tailgate or spare tyre, your bike is always with you.



GARAGE

Installed in the motorhome storage compartment, your bike is stable in any transport.



ACCESSORIES

From rails to bike covers, they enhance the performance of your carry-bike.

CARRY-BIKE

The bike at your fingertips



The bicycle is the ideal way to explore nature or visit a city and its surroundings. This is why Fiamma bike carriers are made in Italy with top quality materials. The rounded tube is in anodized aluminium, while the screws are in stainless steel. Most of the models have an oversized load-bearing structure and are fitted with the Rail Premium or Rail Quick Pro, double reinforced rail with Quick-Safe safety strap. Resistant and safe, they can be installed on any vehicle and accommodate all types of bikes, even E-Bikes.

Selection guide

MOTORHOME



– From page 68

- PRO
- PRO M
- PRO C
- PRO E-Bike 
- PRO C E-Bike 
- UL
- UL 48
- CL
- LIFT 77
- LIFT 77 E-Bike 
- PRO Hymer - Dethleffs
- Autotrail
- Pro C L8o
- Trigano - CI - Roller Team

CARAVAN



– From page 78

- Caravan Active
- Caravan Active E-Bike 
- Caravan XL A
- Caravan XL A Pro
- Caravan XL A Pro 200
- Caravan XL A Pro 200 E-Bike 
- Caravan Hobby
- Caravan Universal
- Simple Plus 200

CAMPERVAN



– From page 87

- VW T6 Pro
- VW T6
- VW T5 Pro
- VW T5
- VW T5 / T6 D
- VW Caddy
- VW T4
- VW T4 D
- VW T3 - T25
- VW T2

VAN CONVERSIONS



– From page 90

- Frame VW Crafter E-Bike 
- Frame Ducato E-Bike 
- 200 DJ Ducato > 2006
- 200 DJ Ducato < 2006 
- 200 DJ Sprinter > 2006
- 200 D

SUV



– Page 94

Backpack

Backpack 4x4

GARAGE



– From page 96

Garage Plus

Garage Standard

Garage Slide Pro Bike

Carry-Moto Pro

Garage Pack

Garage Pack Plus

Carry-Moto

Carry-Ramp



01 Zoom 4 Bikes
is the telescopic rail support with a thicker rounded tube, reinforced elements in stainless steel and aluminium allowing to fit up to 4 bikes.

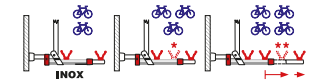

02 Bull Shock Absorber
Bull Shock Absorber is the best and most reliable system for shock and vibration absorption during travel.



03 Bike-Block / Bike-Block Pro S
Anti-scratch, safe and easy to use fixing kit for bicycles. Perfect for all tubes with diameter from 25 to 100mm.



04 Easy Position
Is the system to offset the rails of the bike carrier in order to simplify the transport of multiple bikes at the same time.

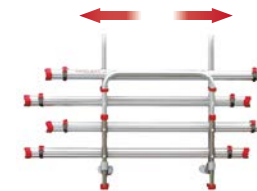

06 Quick Lock
Quick-Safe is the safety strap to safely mount and lock the wheels on the bike carrier rail. Easy release for immediate opening.



07 Rack Holder
It's a locking system which hold the racks of the carrier closed while it is not in use.



05 Rails
Different styles of rails to suit the different Carry Bike models.



Pro Series

Bike carriers designed to be installed on the rear wall of the motorhome.

- for 2 to 4 bikes
- the Support Bar Kit is complete with through screws
- height-adjustable structure
- available in E-Bike version
- Pro C versions are perfect for vehicles with rear window



Pro Series



PRO



PRO E-BIKE



PRO C



PRO C E-BIKE



PRO M

01 Telescopic rail support
To fit up to 4 bikes

02 Easy Position
For the installation of offset rails

03 Bull Shock Absorber
For absorbing shocks and vibrations

04 Bike-Block Pro
Scratch-proof bike lock

05 Rails
The model changes according to technical characteristics (tables on page 177)

06 Rack Holder
Safety carrier lock

07 Support Bar Kit
Lower fixings with bar for easy installation

08 Quick Lock
Quick and safe locking of the wheel to the rail

CHOOSE THE MODEL THAT SUITS YOU For more technical and commercial information, see page 168

	Wheelbase	Weight	Max. load	Bike	Max. bikes
Pro / Pro N* **	80 - 150 cm	8,4 kg	60 kg	2	4
Pro M / Pro M N* **	50 - 80 cm	8,5 kg	60 kg	2	4
Pro C / Pro C N* **	40 - 50 cm	7,9 kg	60 kg	2	4
Pro E-Bike	80 - 150 cm	10,4 kg	60 kg	2	2
Pro C E-Bike	40 - 50 cm	9,9 kg	60 kg	2	2

* The N versions are for vehicles equipped with original Fiamma brackets pre-installed.

** Ask your retailer for availability and timing of blue plastic versions

KIT UPGRADE E-BIKE

Do you have an E-Bike and have you already purchased a PRO model? Thanks to the E-Bike Upgrade Kit you can transform it into a bike carrier for your electric bike.



ADD TO YOUR CARRY-BIKE *

Bike-Block - See page 102 Rail - See page 100 - See page 104

- | | | |
|--|--|--|
| <ul style="list-style-type: none"> • Bike-Block Pro • Bike-Block Pro D • Bike-Block Pro S • Bike-Block Pro S D • Bike Frame Adapter | <ul style="list-style-type: none"> • Rail Premium / XL • Rail Premium S • Rail Premium S Fat Bike • Kit Upgrade E-Bike | <ul style="list-style-type: none"> • Cargo Back • Kit Frame Cargo Back • Ultra-Box 320 - 360 -500 • Cable-Lock • Bike Cover S • Bike Cover Premium S • Easy Dry • Alu Signal • Plastic Signal |
|--|--|--|

* Refer to your retailer to check the compatibility of these accessories with your Carry-Bike



L Series

Light, economical and reliable, to fit up to 3 bikes in total safety.

- for 2 to 3 bikes
- height-adjustable structure



UL



CL



L Series

- | | | | |
|--|--|--|---|
| <p>01 Easy Position
For the installation of offset rails</p> | <p>02 Bike-Block Pro
Scratch-proof bike lock</p> | <p>03 Bull Shock Absorber
For absorbing shocks and vibrations</p> | <p>04 Rack Holder
Safety carrier lock</p> |
| <p>05 Rails
The model changes according to technical characteristics (tables on page 177)</p> | <p>06 Protective bumpers
To protect the bike from impacts with the bike carrier structure</p> | <p>07 Lower fixing bar
Convenient and easy to install</p> | <p>08 Quick Lock
Quick and safe locking of the wheel to the rail</p> |

CHOOSE THE MODEL THAT SUITS YOU For more technical and commercial information, see page 168

	Wheelbase	Weight	Max. load	Bike	Max. bikes
UL*	80 – 150 cm	5,6 kg	50 kg	2	3
CL*	40 – 50 cm	5,6 kg	50 kg	2	3

* Ask your retailer for availability and timing of blue plastic versions

ADD TO YOUR CARRY-BIKE*

Bike-Block - See page 102 **Rail** - See page 100 - See page 104

- Bike-Block Pro
- Bike-Block Pro D
- Bike-Block Pro S
- Bike-Block Pro S D
- Bike Frame Adapter
- Rail Quick Pro
- Rail Premium
- Rail Premium S
- Cargo Back
- Kit Frame Cargo Back
- Ultra-Box 320 - 360
- Cable-Lock
- Bike Cover S
- Easy Dry
- Alu Signal
- Plastic Signal

* Refer to your retailer to check the compatibility of these accessories with your Carry-Bike



Lift 77

The support rail lowers by 77 cm to load and unload bicycles effortlessly.

- for 2 to 4 bikes
- height-adjustable structure
- dropping support rail that lowers by 77 cm
- available in E-Bike version



Lift 77



01 Easy Position
For the installation of offset rails

02 Bike-Block Pro
Scratch-proof bike lock

03 Bull Shock Absorber
For absorbing shocks and vibrations

04 Rack Holder
Safety carrier lock

05 Rails
The model changes according to technical characteristics (tables on page 177)

06 Dropping support rail
Lowers by 77 cm to load and unload bicycles effortlessly

07 Crank handle
With magnetic hooking, it can be shortened

08 Quick Lock
Quick and safe locking of the wheel to the rail



LIFT 77

E-Bike



LIFT 77 E-BIKE

☰ CHOOSE THE MODEL THAT SUITS YOU For more technical and commercial information, see page 169

	Weight	Max. load	Bike	Max. Bikes
Lift 77 *	16,3 kg	60 kg	2	4
Lift 77 E-Bike	18,3 kg	60 kg	2	2

* Ask your retailer for availability and timing of blue plastic versions

+ ADD TO YOUR CARRY-BIKE *

Bike-Block - See page 102 Rail - See page 100 - See page 104

- Bike-Block Pro
- Bike-Block Pro D
- Bike-Block Pro S
- Bike-Block Pro S D
- Bike Frame Adapter
- Rail Quick Pro
- Rail Premium / XL
- Rail Premium S
- Rail Premium S Fat Bike
- Cargo Back
- Kit Frame Cargo Back
- Ultra-Box 320 - 360 - 500
- Cable-Lock
- Bike Cover Premium S
- Easy Dry
- Alu Signal
- Plastic Signal

* Refer to your retailer to check the compatibility of these accessories with your Carry-Bike



Special Models

They are designed to meet the characteristics of certain models of motorhome allowing their installation in a simple and safe way.

- for 2 to 4 bikes
- based on Pro, Pro C and CL
- developed for specific models of motorhomes
- fast and safe installation



Special Models



PRO HYMER - DETHLEFFS



PRO AUTOTRAIL



PRO C L80



TRIGANO - CI - ROLLER TEAM

01 Telescopic rail support
To fit 2, 3 and 4 bikes depending on the model

02 Easy Position
For the installation of offset rails

03 Bull Shock Absorber
For absorbing shocks and vibrations

04 Bike-Block Pro
Scratch-proof bike lock

05 Rails
The model changes according to technical characteristics (see tables on page 177)

06 Rack Holder
Safety carrier lock

07 Specific brackets
For easy and safe installation

08 Quick Lock
Quick and safe locking of the wheel to the rail

CHOOSE THE MODEL THAT SUITS YOU

For more technical and commercial information, see page 169

	Weight	Max. load	Bike	Max. bikes
Pro Hymer - Dethleffs	8,2 kg	60 kg	2	4
Pro Autotrail	12 kg	40 kg	2	2
Pro C L8o	7,9 kg	60 kg	2	4
Trigano - Ci - Roller Team	5,2 kg	50 kg	2	3

KIT DETHLEFFS

For more technical and commercial information, see page 178

For Dethleffs motorhomes, the upper bracket kit is available, adaptable to the standard fitted brackets. To be used in combination with Pro Hymer-Dethleffs Carry-Bike.



Bike-Block - See page 102

- Bike-Block Pro
- Bike-Block Pro D
- Bike-Block Pro S
- Bike-Block Pro S D
- Bike Frame Adapter

Rail - See page 100

- Rail Quick Pro
- Rail Premium
- Rail Premium S
- Rail Premium XL

Accessories - See page 104

- Cargo Back
- Kit Frame Cargo Back
- Ultra-Box 320 - 360 - 500Cable-Lock
- Bike Cover S
- Bike Cover Premium S
- Kit Dethleffs before 2010
- Kit Dethleffs after 2010
- Easy Dry
- Alu Signal
- Plastic Signal

* Refer to your retailer to check the compatibility of these accessories with your Carry-Bike



Caravan

The range of bike carriers for the A-frame of the caravan.

- For 2 to 3 bikes
- installation without drilling holes on standard A-frames
- the Active and Active E-Bike versions, with tensioning strap, allow quick access to the storage compartment
- available two E-Bike versions



Caravan



01 Installation brackets
Supplied as standard. Bike carriers installation without drilling holes on standard A-frames.

02 Protective bumpers
To protect the bike from impacts with the bike carrier structure

03 Quick Lock
Quick and safe locking of the wheel to the rail

04 Bike-Block Pro / Pro S
Bike locking system

05 Rails
The model changes according to technical characteristics (see tables on page 177)

06 Security block
Locks the support rail during transport

07 Tensioning strap
In the Active and Active E-Bike versions it makes access to the storage compartment easy and immediate



CARAVAN ACTIVE

CARAVAN ACTIVE E-BIKE



CARAVAN XL A



new
20
21

CARAVAN XL A PRO



new
20
21

CARAVAN XL A PRO 200



CARAVAN XL A PRO 200 E-BIKE

☰ CHOOSE THE MODEL THAT SUITS YOU

For more technical and commercial information, see page 169-170

	Weight	Max. load	Bike	Max. bikes
Caravan Active	7,4 kg	60 kg	2	3
Caravan Active E-Bike	10 kg	60 kg	2	2
Caravan XL A	5,3 kg	35 kg	2	2
Caravan XL A Pro	9 kg	50 kg	2	3
Caravan XL A Pro Deep Black [New]	9 kg	50 kg	2	3
Caravan XL A Pro 200	7,5 kg	50 kg	2	2
Caravan XL A Pro 200 Deep Black [New]	7,5 kg	50 kg	2	2
Caravan XL A Pro 200 E-Bike	10 kg	60 kg	2	2

+ ADD TO YOUR CARRY-BIKE *

Bike-Block - See page 102

- Bike-Block Pro
- Bike-Block Pro D
- Bike-Block Pro S
- Bike-Block Pro S D
- Bike Frame Adapter

Rail - See page 100

- Rail Quick Pro
- Rail Premium
- Kit Rail Premium 48

Accessories - See page 104

- Cable-Lock
- Bike Cover Caravan

* Refer to your retailer to check the compatibility of these accessories with your Carry-Bike



Caravan

Range of bike carriers designed for installation on the rear walls of caravans.

- for 2 to 3 bikes
- Caravan Hobby for Hobby caravans >2003
- Simple Plus 200 for caravans with curved rear walls



Caravan



01 Aluminium rail support
Light and resistant

02 Easy Position
For the installation of offset rails

03 Bike-Block Pro / Pro S
Bike locking system

04 Rack Holder
Safety carrier lock

05 Rails
The model changes according to technical characteristics (see tables on page 177)

06 Protective bumpers
To protect the bike from impacts with the bike carrier structure

07 Quick Lock
Quick and safe locking of the wheel to the rail



CARAVAN HOBBY



CARAVAN UNIVERSAL



SIMPLE PLUS 200

CHOOSE THE MODEL THAT SUITS YOU For more technical and commercial information, see page 170

	Wheelbase	Weight	Max. load	Bike	Max. bikes
Caravan Hobby	101 cm	5,6 kg	50 kg	2	3
Caravan Universal	100 – 180 cm	7,5 kg	35 kg	2	2
Simple Plus 200	110 – 145 cm	6,6 kg	35 kg	2	2

ADD TO YOUR CARRY-BIKE *

Bike-Block - See page 102

- Bike-Block Pro
- Bike-Block Pro S
- Bike-Block Pro D
- Bike-Block Pro S D
- Bike Frame Adapter

Rail - See page 100

- Rail Quick Pro
- Rail Premium
- Rail Premium S

Accessories - See page 104

- Cable-Lock
- Bike Cover Caravan
- Alu Signal
- Plastic Signal

* Refer to your retailer to check the compatibility of these accessories with your Carry-Bike



VW T5 / T6 PRO

Specific bike carriers for VW T5, T6 and T6.1
Its shape allows the lower part of the tailgate to be left free.

- for 2 to 4 bikes
- you can open the tailgate with the carry-bike mounted without bikes
- T6 Pro versions compatible with T6.1
- Deep Black version



VW T5/T6 Pro



VW T5 PRO



VW T6 PRO

01 Telescopic rail support
To fit up to 4 bikes

02 Easy Position
For the installation of offset rails

03 Bull Shock Absorber
For absorbing shocks and vibrations

04 Bike-Block Pro / Pro S
Bike locking system

05 Rack Holder
Safety carrier lock

06 Rail Premium Rails
Rail with support without adjustment handwheel

07 Upper brackets
Shaped to optimally follow the line of the vehicle

08 Quick Lock
Quick and safe locking of the wheel to the rail

☰ CHOOSE THE MODEL THAT SUITS YOU

For more technical and commercial information, see page 171

	Weight	Max. load	Bike	Max. bikes
VW T5 Pro	14 kg	60 kg	2	4
VW T6 Pro	14 kg	60 kg	2	4
VW T6 Pro Deep Black	14 kg	60 kg	2	4

+ KIT UPGRADE T6 PRO

For more technical and commercial information, see page 178

Have you changed your vehicle and want to reuse your T5 Pro bike carrier on the new T6? Fiamma has thought of a cost-effective solution which allows this operation easily.



+ ADD TO YOUR CARRY-BIKE *

Bike-Block - See page 102

- Bike-Block Pro S D
- Bike Frame Adapter

Rail - See page 100

- Rail Premium / XL
- Rail Premium S
- Rail Premium S Fat Bike
- Kit Premium S

Accessories - See page 104

- Cable-Lock
- Licence Plate Carrier
- Plastic Signal
- Alu Signal

* Refer to your retailer to check the compatibility of these accessories with your Carry-Bike

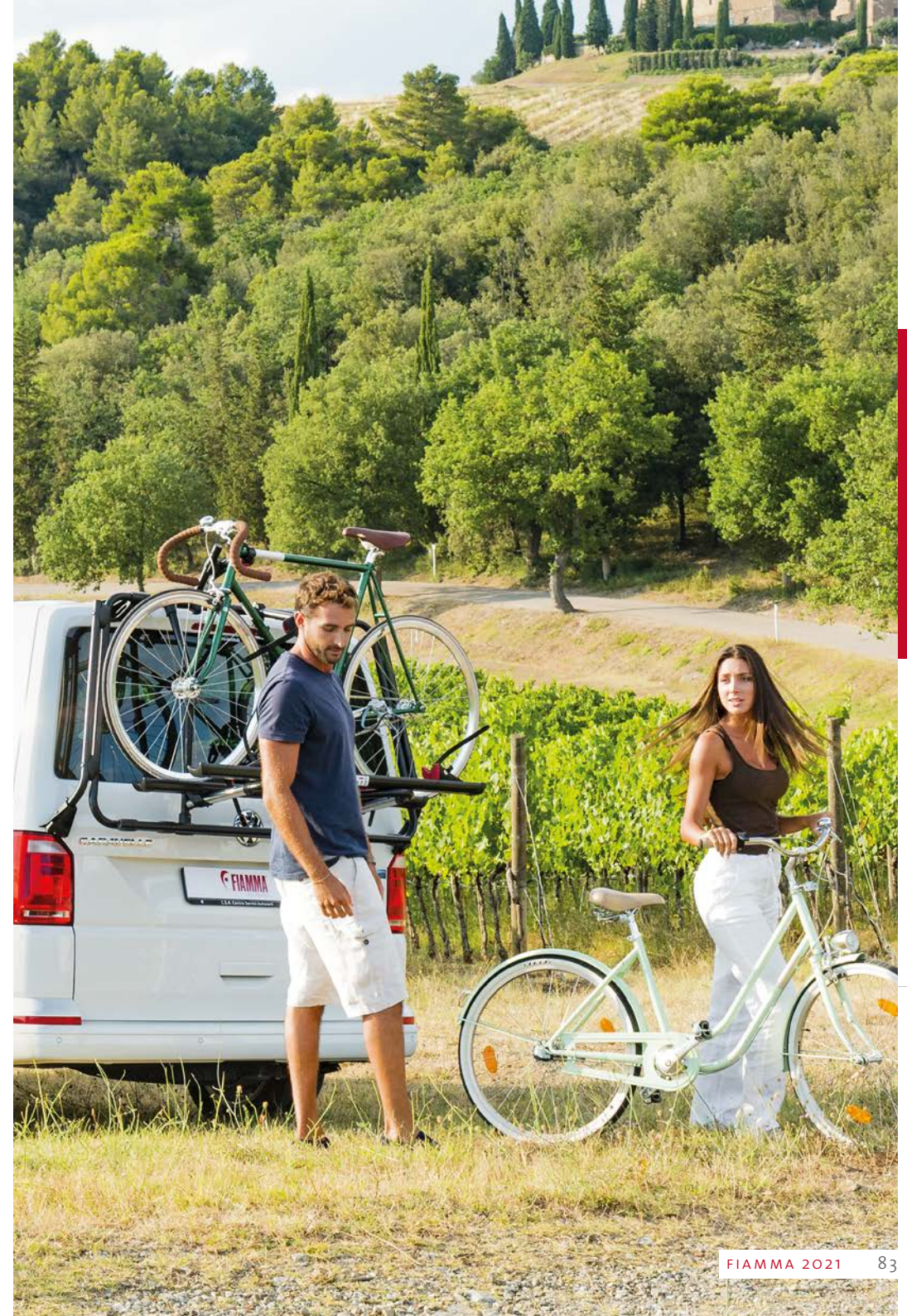

Campervan VW

Range of bike carriers for all VW campervan models.
From VW Caddy to T2.

- for 2 to 4 bikes
- handy bike carrier tensioning system
- the VW Caddy model allows the tailgate to be opened with the bike carrier mounted without bikes
- versions for vehicles with double rear doors



VW T5/T6



VW

01 Rail support

Depending on the model in aluminium or telescopic in stainless steel / aluminium

02 Easy Position

For the installation of offset rails (on hatch models)

03 Tensioning system

For safe and easy fixing of the bike carrier to the vehicle

04 Quick / Premium rails

The model changes according to technical characteristics (see tables on page 177)

05 Rack Holder

Safety carrier lock

06 Upper brackets

Designed to follow the shape of the vehicle



VW T5 / T6



VW T5 / T6 D



VW T4



VW T4 D



VW CADDY



VW T3 (T25)



VW T2

☰ CHOOSE THE MODEL THAT SUITS YOU

For more technical and commercial information, see pages 171-172

	Weight	Max. load	Bike	Max. bikes
Caddy	10 kg	60 kg	2	4
VW T5	8,3 kg	60 kg	2	4
VW T6	8,3 kg	60 kg	2	4
VW T5 D / T6 D *	7,7 kg	35 kg	2	2
VW T4	8,3 kg	60 kg	2	4
VW T4 D *	7,7 kg	35 kg	2	2
VW T3 (T25)	6,5 kg	50 kg	2	3
VW T2	7 kg	35 kg	2	2

* Versions for double rear door

+ KIT UPGRADE T6 / T6.1

For more technical and commercial information, see page 178

Have you changed your vehicle and want to reuse your T5 bike carrier on the new T6? Fiamma has thought of a cost-effective solution which allows this operation easily.



+ ADD TO YOUR CARRY-BIKE *

Bike-Block - See page 102 Rail - See page 100 Accessories - See page 104

- | | | |
|--|--|---|
| <ul style="list-style-type: none"> • Bike-Block Pro D • Bike-Block Pro S • Bike-Block Pro S D • Bike Frame Adapter | <ul style="list-style-type: none"> • Rail Quick Pro • Rail Premium • Rail Premium S | <ul style="list-style-type: none"> • Cable-Lock • Licence Plate Carrier • Plastic Signal • Alu Signal • Dust Guard |
|--|--|---|

* Refer to your retailer to check the compatibility of these accessories with your Carry-Bike

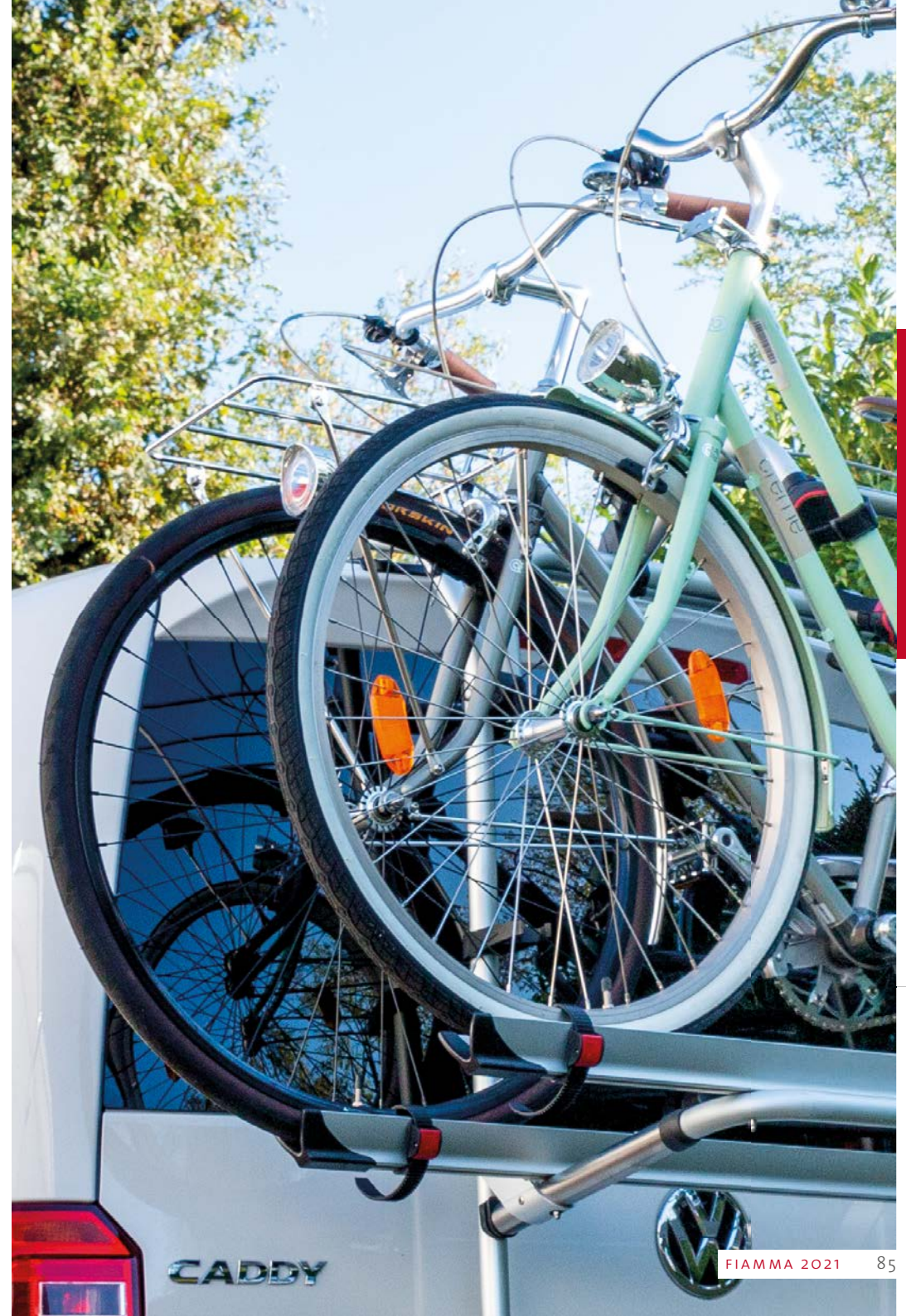

Mercedes Campervan

Dedicated bike carriers for the Mercedes campervan range

- for 2 to 4 bikes
- Mercedes V Class Lift E-Bike: equipped with dropping support rail
- Viano and V Class models allows the tailgate to be opened with the bike carrier mounted without bikes



Mercedes Campervan

- | | | |
|--|---|---|
| <p>01 Rails
The model changes according to technical characteristics (see tables on page 177)</p> | <p>02 Mounting system
Depending on the version, they can be attached to the tailgate or hinges</p> | <p>03 Rack Holder
Safety carrier lock</p> |
| <p>04 Lighting board
Supplied as standard on Viano and V Class versions Lift E-Bike</p> | <p>05 Bike-Block Pro / Pro S
Bike locking system</p> | <p>06 Quick Lock
Quick and safe locking of the wheel to the rail</p> |



VITO



VIANO



V CLASS PREMIUM

E-Bike 



V CLASS LIFT E-BIKE

CHOOSE THE MODEL THAT SUITS YOU

For more technical and commercial information, see page 172

	Weight	Max. load	Bike	Max. bikes
Mercedes Viano	10,0 kg	50 kg	2	3
Mercedes Vito	8,7 kg	60 kg	2	4
Mercedes V Class Premium	12,5 kg	60 kg	2	4
Mercedes V Class Premium E-Bike	20,5 kg	60 kg	2	2

SAFE MOUNTING

In the Viano and Mercedes V Class versions, the upper structure of the bike carrier is screwed to the vehicle chassis through the holes provided by the parent company, avoiding any problems of incorrect positioning during installation.



ADD TO YOUR CARRY-BIKE *

Bike-Block - See page 102

- Bike-Block Pro
- Bike-Block Pro D
- Bike-Block Pro S
- Bike-Block Pro S D
- Bike Frame Adapter

Rail - See page 100

- Rail Premium /XL
- Rail Premium S
- Rail Premium S Fat Bike
- Kit Premium S

Accessories - See page 104

- Cable-Lock
- Licence Plate Carrier
- Plastic Signal
- Alu Signal
- Dust Guard

* Refer to your retailer to check the compatibility of these accessories with your Carry-Bike



Campervan

Versions of bike carriers dedicated to the most popular camper vans on the market.

- for 2 to 4 bikes
- version for Renault Trafic with double rear door.
- Ford Custom and PSA models allow the tailgate to be opened with the bike carrier mounted without bikes
- **new for 2021:** new version dedicated to PSA group camper vans



Campervan



OPEL VIVARO
RENAULT TRAFIC



RENAULT TRAFIC D



FORD TRANSIT



FORD CUSTOM



PSA

- | | | |
|--|---|--|
| <p>01 Rail support
Depending on the model in aluminium or telescopic in stainless steel / aluminium</p> | <p>02 Bike-Block Pro / Pro S
Bike locking system</p> | <p>03 Tensioning system
For safe and easy fixing of the bike carrier to the vehicle</p> |
| <p>04 Rails
The model changes according to technical characteristics (see tables on page 177)</p> | <p>05 Rack Holder
Safety carrier lock</p> | <p>06 Upper brackets
Designed to follow the shape of the vehicle</p> |
| | | <p>07 Quick Lock
Quick and safe locking of the wheel to the rail</p> |

CHOOSE THE MODEL THAT SUITS YOU For more technical and commercial information, see pages 172-173

	Weight	Max. load	Bike	Max. bikes
Opel Vivaro - Renault Trafic	8,7 kg	60 kg	2	4
Renault Trafic D *	8,2 kg	35 kg	2	2
Ford Transit	7,1 kg	50 kg	2	3
Ford Custom	8,2 kg	50 kg	2	3
PSA [New]	10,0 kg	60 kg	2	4

*Version for vehicles with double rear doors

ADD TO YOUR CARRY-BIKE *

Bike-Block - See page 102

- Bike-Block Pro
- Bike-Block Pro D
- Bike-Block Pro S
- Bike-Block Pro S D
- Bike Frame Adapter

Rail - See page 100

- Rail Premium /XL
- Rail Premium S
- Rail Premium S Fat Bike
- Kit Premium S

Accessories - See page 104

- Cable-Lock
- Licence Plate Carrier
- Plastic Signal
- Alu Signal
- Dust Guard

* Refer to your retailer to check the compatibility of these accessories with your Carry-Bike



Frame

Characterised by the solid stainless steel supporting structure, they allow to fit two E-Bikes.

- for 2 E-bikes
- stainless steel supporting structure
- stainless steel rail support base
- Ducato Frame versions allow the rail support base to be mounted in three positions
- The Carry-Bike Frame Ducato E-Bike allows opening of the rear door, even with bikes being mounted to the carrier.



Frame



01 **Stainless steel rail support base**
To withstand load stress

02 **Supporting structure**
Made of stainless steel for maximum fastening

03 **Safe installation**
Using the vehicle's hinge system

04 **Rack Holder**
Safety carrier lock

05 **Bike-Block Pro / Pro S**
Bike locking system

06 **Premium Rails**
Rail with support without adjustment handwheel

07 **Quick Lock**
Quick and safe locking of the wheel to the rail



FRAME DUCATO E-BIKE



FRAME VW CRAFTER E-BIKE

☰ CHOOSE THE MODEL THAT SUITS YOU

For more technical and commercial information, see page 73

	Weight	Max. load	Bike	Max. bikes
Frame Ducato E-Bike* [New]	21 kg	50 kg	2	2
Frame Ducato E-Bike Deep Black* [New]	21 kg	50 kg	2	2
Frame VW Crafter E-Bike* [New]	16 kg	50 kg	2	2

* Not suitable for vehicles with 270° hinge system

+ KIT UPGRADE 3 BIKES

For more technical and commercial information, see page 178

Would you like to transport 3 standard bikes on your Carry-Bike Frame? The replacement of the rail support base (complete with 3 Rail Quick Pro) makes this operation possible by taking full advantage of your bike carrier (suitable for both Ducato and Crafter versions).



+ ADD TO YOUR CARRY-BIKE *

Bike-Block - See page 102 Rail - See page 100 Accessories - See page 104

- | | | |
|--|--|---|
| <ul style="list-style-type: none"> • Bike-Block Pro S • Bike-Block Pro S D • Bike Frame Adapter | <ul style="list-style-type: none"> • Rail Premium • Rail Premium S | <ul style="list-style-type: none"> • Cable-Lock • Licence Plate Carrier • Plastic Signal • Alu Signal |
|--|--|---|

* Refer to your retailer to check the compatibility of these accessories with your Carry-Bike



Van conversions

They are installed on the right door leaving the left door free for the possible installation of a Deluxe ladder to access the roof of the vehicle

- for 2 bikes
- installation with Fixing Bar for Ducato and Sprinter/ Crafter versions
- the 200 D version has adjustable wheelbase from 90 to 118 cm
- the version for Ducato >2006 allows the rail support to be mounted in three positions



Van conversions

- 01 Structure**
Solid and lightweight aluminium
- 02 Fixing Bar**
Upper and lower installation bars
- 03 Rails**
The model changes according to technical characteristics (see tables on page 177)
- 04 Rack Holder**
Safety carrier lock
- 05 Bike-Block Pro / Pro S**
Bike locking system
- 06 Quick Lock**
Quick and safe locking of the wheel to the rail



200 DJ DUCATO > 2006



200 DJ DUCATO < 2006



200 DJ SPRINTER / CRAFTER



200 D

CHOOSE THE MODEL THAT SUITS YOU For more technical and commercial information, see pages 173-174

	Weight	Max. load	Bike	Max. bikes
200 DJ Ducato > 2006	11 kg	35 kg	2	2
200 DJ Ducato > 2006 Deep Black	11 kg	35 kg	2	2
200 DJ Ducato < 2006	9 kg	35 kg	2	2
200 DJ Sprinter / Crafter > 2006	9 kg	35 kg	2	2
200 DJ Sprinter / Crafter > 2006 Deep Black [New]	9 kg	35 kg	2	2
200 D	6,9 kg	35 kg	2	2

+ ADD TO YOUR CARRY-BIKE *

Bike-Block - See page 102

- Bike-Block Pro S
- Bike-Block Pro S D
- Bike Frame Adapter

Accessories - See page 104

- Cable-Lock
- Licence Plate Carrier
- Alu Signal
- Plastic Signal
- Dust Guard

* Refer to your retailer to check the compatibility of these accessories with your Carry-Bike



SUV

Strap fixing.

Simple and effective bike carrier solutions designed for SUVs, 4x4 vehicles and cars.

- for 2 to 3 bikes
- Backpack is the most versatile solution and can also be easily installed in MPVs
- Backpack 4x4 is designed to be mounted on the rear spare tyre.



SUV

01 Aluminium rail support
Solid and light

02 Fastening straps
For maximum freedom of fastening on the vehicle

03 Bike-Block Pro
Bike locking system

04 Rail Quick C / Rail Quick C Strip
Adjustable telescopic rail.
Ideal to limit rail overhang.

05 Quick Lock
Quick and safe locking of the wheel to the rail



BACKPACK



BACKPACK 4x4

☰ CHOOSE THE MODEL THAT SUITS YOU

For more technical and commercial information, see page 174

	Weight	Max. load	Bike	Max. bikes
Backpack	8 kg	50 kg	2	3
Backpack 4x4	6,9 kg	35 kg	2	2

+ ADD TO YOUR CARRY-BIKE *

Bike-Block - See page 102

Rail - See page 100

Accessories - See page 104

- Bike-Block Pro S
- Bike-Block Pro S D
- Bike Frame Adapter

- Rail Quick C

- Cable-Lock
- Alu Signal
- Plastic Signal

* Refer to your retailer to check the compatibility of these accessories with your Carry-Bike



Garage

Keep bicycles safe in the motorhome storage compartment.

- adaptable to different types of vehicles
- easy to install



Garage



GARAGE PLUS

Bike carrier for motorhomes with garage facility. With optional accessories carries up to 4 bikes. When not in use, it can be folded up and covers only 22 cm.



GARAGE SLIDE PRO-BIKE

Anodized aluminium sliding bike carrier for the motorhome garage.



GARAGE STANDARD

Bike carrier with lower section fastened to the floor and Bike-Block fixed to the wall or to the roof. When folded it gives more floor space, it carries up to 3 bikes.



GARAGE PACK-PLUS

Complete kit with fixing structure for bikes and Organizer line storage.

☰ CHOOSE THE MODEL THAT SUITS YOU

For more technical and commercial information, see page 175

	Weight	Max. load	Bike	Max. bikes
Garage Plus	5,6 kg	60 kg	2	4
Garage Standard	4,8 kg	50 kg	2	3
Garage Slide Pro Bike	9,9 kg	50 kg	2	2
Garage Pack Plus	10,5 kg	50 kg	2	3
Garage Pack	4 kg	35 kg	2	3

+ ADD TO YOUR CARRY-BIKE *

Bike-Block - See page 102

Rail - See page 100

Accessories - See page 104

- Bike-Block Pro
- Bike-Block Pro D
- Bike-Block Pro S
- Bike-Block Pro S D

- Rail Quick Pro
- Rail Premium / XL

- Bike Frame Adapter
- Cable-Lock



GARAGE PACK

Simple and flexible modular system.

* Refer to your retailer to check the compatibility of these accessories with your Carry-Bike



Moto

Motorbike carrier systems ideal for installation in motorhomes with garage facilities or on vans.

- adaptable to different types of vehicles
- easy to install



CARRY-RAMP

Motorbike aluminium ramp, suitable for motorhome doors or on the floor of the garage facility.



CARRY-MOTO

Motorbike-carrier in aluminium for garage. The chute connects easily onto the main structure to facilitate loading of the motorbike. Supplied as standard with 2 click strips.



MOTO WHEEL CHOCK FRONT

Wheel chock for front wheel. Complete with kit for fixing on wood surfaces. Supplied as standard with 2 click strips.



CARRY-MOTO PRO

Motorbike-carrier in aluminium for garage. The pull-out chute is coated with an anti-slip band. Supplied as standard with 2 click strips.



MOTO WHEEL CHOCK REAR

Wheel chock for rear wheel. The adjustment knobs allow the motorbike to be locked quickly and safely. Supplied as standard with rails for floor fixing.

CHOOSE THE MODEL THAT SUITS YOU

For more technical and commercial information, see page 175

	Weight	Max. load	Chute extension	Max. wheel width
Carry-Moto	12,2 kg	200 kg	180 cm	14 cm
Carry-Moto Pro	15,4 kg	200 kg	155 cm	16 cm
Carry-Ramp	7 kg	130 kg	175 cm	15 cm
Moto Wheel Chock Front	2,4 kg	-	-	18 cm
Moto Wheel Chock Rear	2,8 kg	-	-	15 cm

CARRY-RAMP

By combining two pieces of the Carry-Ramp you can create a system of ramps to load quads, powered wheelchairs or wheelchairs.

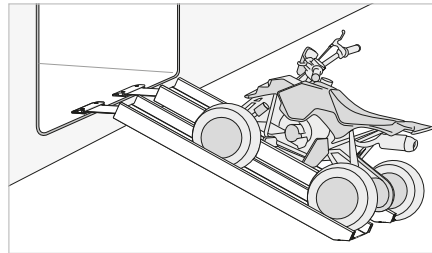

Moto

* Refer to your retailer to check the compatibility of these accessories with your Carry-Bike



Rail



RAIL QUICK PRO

Sturdy rail with reinforced base delivered with Quick-Safe straps. Available in three colours and in the Deep-Black version. It is interchangeable with the previous Rail Quick version.



black blue grey deep black



RAIL PREMIUM / PREMIUM XL

Rail with increased structure size, with bike-lock support and without adjustment handwheel for quicker and more practical fixing. The XL version is 139 cm longer and is suited for particularly long E-Bikes and bikes with wheelbase greater than 125 cm



black Deep Black



RAIL STRIP PRO

Sturdy rail with reinforced base. Complete with 2 sliding straps. It is interchangeable with the previous Rail Strip version.



black



RAIL PREMIUM S

Rail with increased structure size sliding on the Carry-Bike rail support, it can move in both direction and has adjustable centre-to-centre distance.



black Deep Black



RAIL QUICK C

Telescopic rail that can be adjusted to the desired extension, with 2 Quick-Safe straps. Ideal to limit rail overhang. It can be installed on almost all Carry-Bikes.



black



RAIL PREMIUM S FAT BIKE

Model based on Premium S rail for transporting modern Fat Bikes with tyres up to 5" wide. Comfortable 40cm strap with fast and safe ratchet coupling..



black Deep Black

 CHOOSE THE MODEL THAT SUITS YOU

For more technical and commercial information, see page 177

	Colour	Length	Right/Left sliding	Forward-back sliding	Weight
Rail Quick Pro	black / blue / grey / deep black	128 cm	●	●	1,0 kg
Rail Strip Pro	black	128 cm	●	●	1,0 kg
Rail Quick C	black	89-150 cm	●	●	1,2 kg
Rail Premium		128 cm	●	●	1,3 kg
Rail Premium XL		139 cm	●	●	1,9 kg
Rail Premium S	black / deep black	128 cm	●	●	1,7 kg
Rail Premium S Fat Bike		128 cm	●	●	2,0 kg
Kit Rail Premium 48		48 cm	●	●	0,8 kg

● Standard ● Using Premium S Kit

**KIT PREMIUM S**

Turn Quick and Premium rails into Premium S rails. Quick installation by removing the standard hooks. Now rails can slide horizontally, to be adapted to the dimensions of the different bikes.



2x

KIT RAIL PREMIUM 48

Optional fourth two-part rail for the Carry-Bike VW T5 Pro and T6 Pro models.



Black

Deep Black

Bike-Block Pro S

Articulated arm :
it allows to adapt to any type of bike.
Secure fixing system with clamp and scratch-
proof rubber insert

- Improved ergonomics thanks to the frontally positioned fixing knob
- integrated scratch-proof support base with rubber protection for integrated bike hooking
- Safer thanks to the buttonhole that allows the attachment of an anti-theft cable

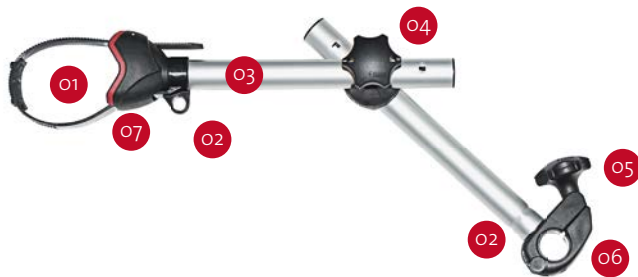

01 Bike support base
For round or oval tubes
Ø 25 - 100 mm

02 Safety buttonhole
To use an anti-theft cable
when fixing the bikes

03 Aluminium tube
Light and resistant
Ø 30 mm

04 Articulated arm
On D versions only.
Guarantees a high degree
of freedom of adjustment

05 Fixing knob
In front position, always
within easy reach.

06 Locking clamp
For Ø 28 - 35 mm pipes

07 360° rotation
For bike support and
locking clamp

CHOOSE THE MODEL THAT SUITS YOU

For more technical and commercial information, see page 176

	Colour	Weight
Bike-Block Pro S 1	black	0,2 kg
Bike-Block Pro S 2		0,3 kg
Bike-Block Pro S 3		0,4 kg
Bike-Block Pro S 4		0,5 kg
Bike-Block Pro S D1	black / deep black	0,6 kg
Bike-Block Pro S D2		0,7 kg
Bike-Block Pro S D3	black	0,8 kg



BIKE-BLOCK PRO S 1



BIKE-BLOCK PRO S 2



BIKE-BLOCK PRO S 3



BIKE-BLOCK PRO S 4



BIKE-BLOCK PRO S D1



BIKE-BLOCK PRO S D2



BIKE-BLOCK PRO S D3

Bike-Block Pro

Articulated arm adapting to any type of bike.
Secure fixing system with clamp and scratch-proof rubber insert

- The knob and the bike locking system can rotate 360°



01 Bike support base
For round or oval tubes
Ø 25 - 100 mm

02 360° rotation
For bike support and locking clamp

03 Aluminium tube
Curved to make it easier to attach the bike Ø 30 mm

04 Fixing knob
To lock the Bike-Block to the Carry-Bike

05 Locking clamp
For Ø 28 - 35 mm pipes

CHOOSE THE MODEL THAT SUITS YOU

	Colour	Weight
Bike-Block Pro 1		0,2 kg
Bike-Block Pro 2	black / blue / grey	0,3 kg
Bike-Block Pro 3		0,4 kg
Bike-Block Pro 4		0,5 kg
Bike-Block Pro D1	black / red	0,6 kg
Bike-Block Pro D2		0,7 kg
Bike-Block Pro D3	black	0,8 kg

For more technical and commercial information, see page 176

ADD TO YOUR CARRY-BIKE



BIKE FRAME ADAPTER

Additional aluminium bar for easy fixing of bikes without standard centre bar, ladies' bikes and BMXs.

BIKE-BLOCK PRO 1



BIKE-BLOCK PRO 2



BIKE-BLOCK PRO 3



BIKE-BLOCK PRO 4



BIKE-BLOCK PRO D1



BIKE-BLOCK PRO D2



BIKE-BLOCK PRO D3



Locking System

Accessories, for additional load locking, for Fiamma and non Fiamma Carry-Bikes.



+ CHOOSE THE MODEL THAT SUITS YOU

For more technical and commercial information, see page 178



QUICK-SAFE

Sliding strap to lock the wheel to the rail.
With immediate release button.



STRIP

Kit of 2 strips, 39 cm long, with stainless steel buckle suitable for almost all bike carrier brands. Two pieces per packaging.



SECURITY STRIP

200 cm security strip, with stainless steel buckle, 200 cm long and 1.3 cm wide. Suitable for all bike carriers
One piece per packaging.



CABLE-LOCK

Anti-theft plastic-coated 250 cm steel cable, with incorporated padlock.

Installation Kit

Kit of mounting bars and accessories for the installation of Fiamma Carry-Bikes.



+ ADD TO YOUR CARRY-BIKE



FIXING-BAR CARRY-BIKE

Pair of 240 cm long reinforcement bars ideal for vehicles with rear walls not equipped with internal reinforced points

new
20
21



LICENCE PLATE CARRIER

Licence plate carrier bar in aluminium with regulation lights and 13-pole socket for quick connection to the vehicle's electrical system.

It is used when the rail support covers the lights and the licence plate of the vehicle. The bar turns 90° to be positioned correctly even when the rail support is folded up.

For more technical and commercial information, see page 178

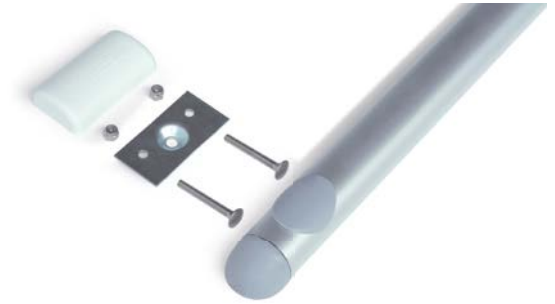

SUPPORT BAR KIT

Kit of two pre-drilled anodized aluminium bars to fix the bike carrier to the walls of motorhomes.



DUST GUARD

Guard to prevent the accumulation of debris inside the Fixing-Bar.

Bike covers and accessories

Protect your bikes with the range of lightweight, water-proof polyester reinforced resin bike covers.

- for 2 to 4 bikes
- bi-colour finish
- S and Premium S versions are equipped with a transparent material pocket, with Velcro, to insert the protruding load sign.

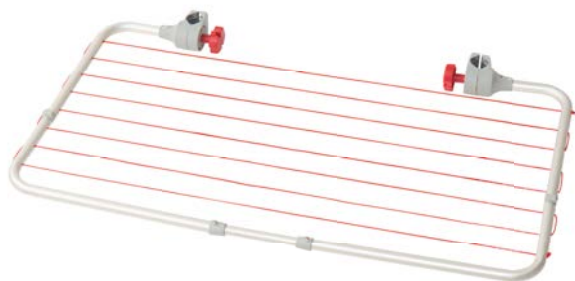

EASY DRY

Practical drying rack adaptable to rail supports of the bike carrier. Equipped with a folding rail support base, you can travel with the drying rack fixed on.



BIKE COVER S

Closure with elastic band at the bottom and metal hooks. Delivered with transparent pocket for protruding load signs



ALU SIGNAL

Type-approved sign, in light aluminium, for signalling protruding loads. Mandatory in Italy. Dimensions: 50x50 cm.



BIKE COVER S PREMIUM

For complete bike protection. Closes with side zipper and rear Velcro. Delivered with transparent pocket for protruding load signs



PLASTIC SIGNAL

Non type-approved plastic sign for signalling protruding loads, with four reflectors. Dimensions: 50x50 cm.



BIKE COVER CARAVAN

Specific for bike carriers mounted on the A-frame of caravans. It is placed on top of the bikes already mounted on the rail support. The closure is of the drawstring type with a cable clip.

☰ CHOOSE THE MODEL THAT SUITS YOU

	Bikes covered	Vehicle type	Closing system
Bike Cover	2 / 3		Elastic band with hooks
Bike Cover Premium S	4	Motorhome	Zippers
Bike Cover Caravan	2	Caravan	Elastic band with lock



Rear boxes

Rear boxes to be installed above the bike carrier rail support.

- in ABS or strong tear-resistant polyester
- Three dimensions: from 300 to 500 litres
- The Cargo-Back soft luggage bag is equipped with a transparent material pocket, with Velcro, to insert the protruding load sign.



Ultra-Box 320



Ultra-Box 360



Ultra-Box 500

ULTRA-BOX

Made of high resistance ABS to last over time. With stainless steel closing zippers and internal aluminium profile it is also equipped with a net to secure the transported items. Available with 320, 360 and 500-litre capacities



Rear boxes



CARGO BACK

Soft luggage bag made of waterproof and tear-resistant polyester. Delivered with transparent pocket for protruding load signs.



FRAME CARGO BACK KIT

Aluminium tube and plastic structure to be inserted inside the Cargo Back to keep it tensioned in any load situation.

 CHOOSE THE MODEL THAT SUITS YOU

	Volume	External dimensions	Internal dimensions	Weight
Ultra-Box 320	320 l	100x53x70 cm	88,5x46x62 cm	12,0 kg
Ultra-Box 360	360 l	147x38x70 cm	133,5x30x58 cm	14,0 kg
Ultra-Box 500	500 l	147x53x70 cm	133,5x46x62 cm	17,0 kg
Cargo Back	285 l	120x70x35 cm		1,4 kg
Kit Frame Cargo Back		119x69x32 cm		1,2 kg

For more technical and commercial information, see page 179





ROOFLIGHTS

Different types of rooflights, to adapt to each type of vehicle.



LIGHTING

Find the right lighting among the various proposals for indoor and outdoor LEDs.



WATER

Save water or store it in the best possible way with special pumps and tanks.



LEVELLING SYSTEMS

Various models of level and accessories to safely stabilize your vehicle.



ORGANISATION

Arrange everything in the most suitable place, to have everything always in order.



SAFETY

Take big and small precautions to make your holiday safer.



LADDERS

Indoors and outdoors, different models to best suit your vehicle.



HYGIENE

Keep the environment clean and hygienic thanks to portable toilets and specific sanitary accessories.



VEHICLE COVERS

Protect your vehicle from the weather.



MIX

Various products and accessories to complete your Comfort range.

COMFORT

Comfort throughout the journey

To make you feel at home in every stop and move, Fiamma has created a complete range of devices and accessories that will equip your vehicle with every comfort. Designed with attention to aesthetics and functional in every condition, Fiamma products cover every need that you and your travelling companions may have.

Each solution is designed to occupy as little space as possible while giving you maximum performance.

Vent 28 F

Ideal for smaller environments, it can be motorised using the Turbo-Vent 28 F Kit.

- 28x28 cm
- discreet and elegant design
- available in White and Crystal versions
- standard mosquito net
- motorised



Vent 28 F



01 Aerodynamic
Its shape means that no spoiler is needed

02 Sandwich assembly
Quick installation without needing to cut more holes in the roof of your vehicle

03 Permanent ventilation
For constant exchange of air

04 Opening system
With handy handwheel

05 Mosquito net
Made of aluminium, easily removable for cleaning

06 Slim frame
Minimum vertical dimensions on the vehicle ceiling

07 Motorised
With the Turbo-Vent 28 F Kit

 CUSTOMIZE YOUR ROOFLIGHT

 White

 Crystal

 CHOOSE THE MODEL THAT SUITS YOU

For more technical and commercial information, see page 180

	Weight
Vent 28 F White	1.8 kg
Vent 28 F Crystal	

 ADD TO YOUR VENT 28 F

For more technical and commercial information, see page 180

**TURBO-VENT 28 F KIT**

To motorise your Vent 28 F.

Power supply	12 V
Power consumption	25 W
Maximum input	1.9 A
Maximum air flow	9 m ³ /min
Fan diameter	18 cm
Permanent air flow	50 cm ²



Vent F Pro

Ideal for motorhomes, caravans and vans, motorised with 3 different types of Turbo-Vent F Kits.

- 40x40 cm
- elegant and stylized design
- mosquito net and pleated blinds as standard
- motorised



Vent F Pro



Kit Turbo-Vent

MODEL

	Weight
Vent F Pro	4,0 kg

01 Aerodynamic
Its shape means that no spoiler is needed

02 Sandwich assembly
Quick installation without needing to cut more holes in the roof of your vehicle

03 Opening
Double opening arm for maximum cover stability

04 Mosquito net and blind
Removable mosquito net and pleated blind

05 Handwheel
Handy for an easy opening

06 Motorised
With 3 different versions of Turbo-Vent F kit.

ADD TO YOUR VENT F PRO

For more technical and commercial information, see page 180



KIT TURBO-VENT F PREMIUM

Equipped with "Touch" electronic control unit and Polar Control thermostat as standard.



TURBO-VENT F KIT

Standard version equipped with Polar Control thermostat.



TURBO-VENT F KIT P3

Basic version not equipped with Polar Control.

	Kit Turbo-Vent F Premium	Kit Turbo-Vent F	Kit Turbo-Vent F P3
Power supply	12 V	12 V	12 V
Power consumption	36 W	36 W	36 W
Minimum absorption	0,3 A	0,3 A	0,3 A
Maximum input	3 A	3 A	3 A
Maximum air flow	35 m ³ /min	35 m ³ /min	35 m ³ /min
Polar Control function	●	●	-
Touch function	●	-	-

Vent / Turbo-Vent

Ideal for motorhomes, caravans and vans, also available in motorised version.

- 40x40 cm
- available in White and Crystal versions
- standard mosquito net, optional blind
- motorised versions also available



01 Aerodynamic
Its shape means that no spoiler is needed

02 Installation
With through screws, wide and reinforced frame

03 Permanent ventilation
For constant exchange of air

04 Opening system
With handy handwheel

05 Mosquito net
In aluminium as standard

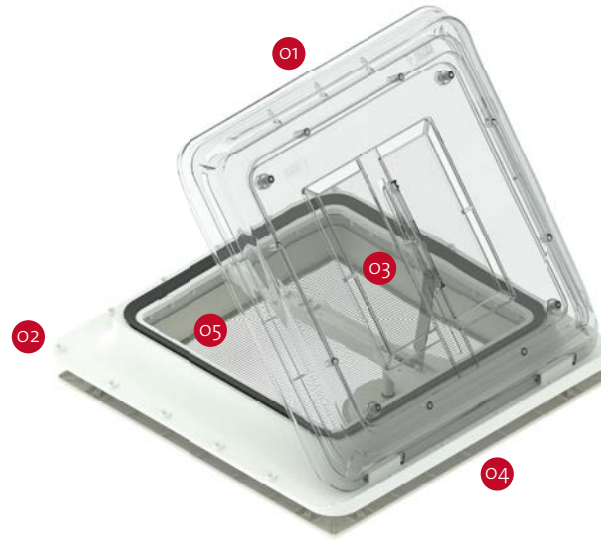

CUSTOMIZE YOUR ROOFLIGHT

Cover finish

White

Crystal



Turbo-Vent Premium



Turbo-Vent



Vent

CHOOSE THE MODEL THAT SUITS YOU

	Turbo-Vent Premium	Turbo-Vent	Vent
Power consumption	36 W	36 W	-
Minimum absorption	0,3 A	0,3 A	-
Maximum input	3 A	3 A	-
Maximum air flow	35 m ³ /min	35 m ³ /min	-
Polar Control thermostat	•	•	-
Touch electronic control unit	•	-	-

For more technical and commercial information, see page 181



TURBO-VENT PREMIUM

Rooflight with motor where all functions are activated by a simple finger touch. Convenient electronic interface with signal LEDs.



TURBO-VENT

Classic rooflight with 12 V DC variable speed motor.



VENT

Rooflight without motor equipped with permanent air flow ventilation and mosquito net.

Vent 50

Rooflight with pantograph opening.

- 50x50 cm
- available in White and Crystal versions
- standard mosquito net and blinds



Vent 50



01 Opening
Pantograph type

02 Handles
Locking anti-theft device

03 Permanent ventilation
For constant exchange of air

04 Mosquito net and blind
Supplied as standard, aluminium blind

05 Sandwich assembly
Quick installation without needing to cut more holes in the roof of your vehicle

CUSTOMIZE YOUR ROOFLIGHT

Cover finish



White



Crystal

MODEL

	Weight
Vent 50	4,5 kg

For more technical and commercial information, see page 180

Turbo-Kit

Additional fan, easy and quick to install on almost all rooflights.

- it can be installed on rooflights from 40x40 (not Fiamma) up to 50x70 cm
- composed of a ventilation system with fan and telescopic hangers



Polarity inverter:
from fan to aspirator

FEATURES

For more technical and commercial information, see page 181

Power supply	12 V
Power consumption	4 W
Minimum absorption	0,2 A
Maximum input	0,33 A
Maximum air flow	7,2 m ³ /min
Fan diameter	24 cm



Turbo-Kit



Accessories



UNIVERSAL SPOILER

It can be shortened to fit to the different rooflight dimensions. Complete with side aerodynamic end caps.



SPOILER 40

Designed to fit the non-aerodynamic 40x40 rooflights. Easily installed with the roof vent screws or attached with suitable adhesives (Sika).



THERMO VENT 40

Vent insulation that reflects sun light and prevents cold air from entering. It can be installed on all 40x40 cm rooflights.



ROLLO VENT 40

Roller blind designed for installation on Vent 40x40 cm rooflights



LEDs for awnings

To illuminate your space using the arms and rails of the awning.

- average LED duration 25,000 hours
- Super Bright LEDs, \varnothing 5 mm
- 12 V power supply



LED for awning



LED for
tension rafter



AWNING ARMS LED

Four pairs of LED lights that are easily attached to the articulated arms of the awnings and remain mounted allowing the awning to be closed completely.



AWNING CASE LED

LED light bar to be inserted in the special case box housing of F45s, F45L and F70 WINCH AWNINGS.



AWNING LED KIT

Installation by simply pushing on the lead bar, for a permanently fixing.



STRIP AWNING LED KIT

Specific for F65L and F80s AWNINGS consisting of a 5 m LED sticky strip and PVC lens, which can be easily shortened.

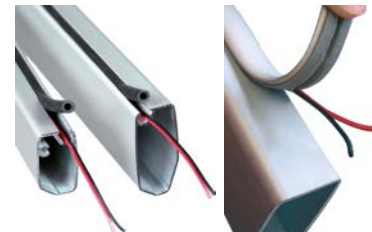

CABLES KIT

For hiding electrical cables in the awning. Can be used with Awning Arms LED (1 kit) and Awning LED kit (2 kits).



RAFTER LED

For case box awnings.
Supplied complete with hooks to be installed in the awning F45 (for F65s and F65L the optional kit is available) which incorporate the electrical connections: simply place the rafter on and the LEDs will come on.

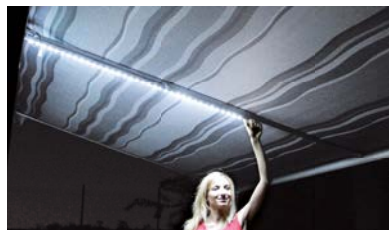

RAFTER LED CARAVANSTORE

Specific for Caravanstore awning.
Equipped with a spring terminal to be easily installed when the awning is open and a power cable.

CHOOSE THE MODEL THAT SUITS YOU

	Power	Power input	Lm/m
Awning Arms LED	4 W	0.36 A	382
Kit Awning LED	2.4 W	0.20 A	170
Kit LED Strip Awning High Brightness	4.8 W	4.00 A	840
Kit LED Strip Awning	2.4 W	2.00 A	420
Kit Cables Guide	-	-	-
Kit Cable Rail	-	-	-
LED Awning Case	2.7 W / bar	0.23 A / bar	168
Kit LED Awning Case 50	2.7 W / bar	0.23 A / bar	168
Rafter LED	9.7 W	0.80 A	792
Rafter LED CaravanStore	9.7 W	0.80 A	792

For more technical and commercial information, see page 182



LED for outdoors and garage

To illuminate the outdoor space and your garage.

- average LED duration 25,000 hours
- Super Bright LEDs, \varnothing 5 mm



LED for outdoor
and garage



LED for door
and step



AWNING LIGHT LED

External LED light for awnings, which can be installed under the awning case box or above the entrance door.



GARAGE LIGHT LED

Internal LED light for storage compartments and garage facilities, complete with switch.



WARNING SOLAR LEDS

System of two intermittent signal lights. Ideal to be positioned around your motorhome and caravan to highlight a dangerous area.



SENSOR DOOR LIGHT LED

With PIR and light sensor, it only lights up at night when a person approaches your vehicle; the lights remains on for 60 seconds. Designed to be installed above the doors of motorhomes and caravans.



STEP LED

To increase the safety and visibility of the steps and step wells at the entrance of the motorhome.



AWNING LIGHT GUTTER LED

External door light, equipped with terminals shaped as a channel, ideal to solve the annoying problem of rain dripping from above the door.

CHOOSE THE MODEL THAT SUITS YOU

For more technical and commercial information, see page 183

	Power	Power input	Lm/m
LED Awning Light	7.4 W	0.62 A	547
LED Garage Light	7.4 W	0.62 A	547
LED Warning Solar	0.03 W	0.012 A	-
LED Sensor Door Light	7.4 W	0.62 A	547
LED Step	1.7 W	0.14 A	145
LED Awning Light Gutter	7.4 W	0.62 A	547



Water pumps

Safe and reliable pumps, to guarantee a constant and high flow on your vehicle.

- anti-vibration base
- motor with thermal protection
- standard stainless steel filter removable for easy cleaning
- it can be installed in any position, can run dry without damage



AQUA F

Equipped with an internal diaphragm made in a single piece to ensure its watertight seal. 4 chambers for high flow of water. Standard filter. Available in 10 and 13 litres versions.



AQUA 8

Aqua 8 is the classic self-priming pump with incorporated filter and anti-vibration Silent Plate base as standard. Angle and straight connectors for 13 mm pipes included. Available in 7 and 10 litres versions.



A20

Universal expansion tank that eliminates pulsating pump operation and supplies a constant flow of water in the required quantity.



Water pumps

 CHOOSE THE MODEL THAT SUITS YOU For more technical and commercial information, see page 184

	Current input	Flow rate at 0 bar	Noise	Pressure switch intervention	Weight
Aqua F (13 litri)	2,5 A	13 l/min	50 db	1,5 Bar 21,7 Psi	2,2 kg
Aqua F (10 litri)	1,7 A	10 l/min	52 db		1,4 kg
Aqua 8 (7 litri)	1,4 A	7 l/min	55/60 db		1,5 kg
Aqua 8 (10 litri)	3,4 A	10 l/min	65/70 db		1,5 kg
A20	-	-	-	-	0,3 kg

Power supply: 12 V



Tanks

Water is a precious resource to take care of. Blue tanks made of food grade material and grey water tanks for waste water are easy to fill, transport and empty.

- watertight cap
- easy to transport
- compact size



ROLL-TANK 23F

Convenient portable fresh water tank with easy access discharge cap. Compact size (fits through normal vehicle doors). Complete with extra cap for immersion pump (not included).



new
20
21

ROLL-TANK 40F

Portable fresh water tank, easy grip handle and silent rubber wheels make transportation easy even on gravel. Easy cleaning wide filler cap.



new
20
21

TANK 70

Large fresh water tank, it can be installed vertically or horizontally, it is complete with all the fittings.



New closing cap for Roll-Tank 40 and Tank 70 models. The central easy grip handle on the cap improves ergonomics and makes it easier to open and close the tank.



ROLL-TANK 23W

Convenient portable waste water tank with easy access discharge cap. Compact size (fits through normal vehicle doors).



new
20
21

ROLL-TANK 40W

Waste water tank, includes a vent valve and level indicator. Connects to the valve of the motorhome tank via the drain tube. The 45° angle adapter for drain is included.



Blue tanks



Grey tanks



SANITARY FLEX KIT

Flexible and extendable up to 300 cm, the hose is complete with 2 connections and clamps for connection to the Roll-Tank 40 W, Tank 21 W and Quick Connection W.



QUICK CONNECTION W

The adapter to turn the threaded connection into a bayonet connection so that the Sanitary Flex can be easily coupled to the Tank 23 W.



WATER CAP

Thanks to the key, the cap can be locked and opened for greater security.

CHOOSE THE MODEL THAT SUITS YOU

	Capacity	Weight
Roll-Tank 23F	22,5 l	2,4 kg
Roll-Tank 40F [New]	35 l	3,8 kg
Tank 70 [New]	65 l	4,4 kg
Water Cap	–	0,2 kg
Roll-Tank 23W	22,5 l	2,4 kg
Roll-Tank 40W [New]	35 l	3,9 kg
Kit Sanitary Flex	–	0,8 kg
Quick Connection W	–	0,2 kg

For more technical and commercial information, see page 184



Levelling systems

Various models of levels to safely stabilize your vehicle.

- equipped with levelling cradles
- easy to transport and lightweight
- resistant



PREMIUM LEVEL UP KIT

With three levelling cradles, handle for a safe and easy positioning of the product under the vehicle and high manoeuvrability. Delivered as standard with Level Bag Premium. Ideal for motorhomes.



LEVEL UP PREMIUM S KIT

Same features as the Level Up Premium Kit, but with reduced size and weight to fit not only motorhomes but also van conversions. Delivered as standard with Level Bag.



LEVEL UP - LEVEL UP KIT

Ridged surface to grip to the vehicle's tyres. Consists of three levels, lightweight and easy to clean. The Kit version is complete with Level Bag.



Level



Level accessories



LEVEL PRO

Ideal for caravans and camper vans. Practical self-locking overlapping interlocking levelling system to raise height. Non-skid finish.



LEVEL SYSTEM MAGNUM

Ideal for motorhomes. Practical self-locking overlapping interlocking levelling system to raise height.



LEVEL SYSTEM JUMBO

Ideal for motorhomes with twin wheels.

 CHOOSE THE MODEL THAT SUITS YOU

For more technical and commercial information, see page 185

	Dimensions	Levels	Capacity	Weight each
Kit Level Up Premium *	83x31x20 cm	3	5,0 t	3,7 kg
Kit Level Up Premium S * [New]	68x28x16 cm	3	5,0 t	2,1 kg
Level Up - Kit Level Up	57x20x13 cm	3	5,0 t	1,45 kg
Level Pro	43x17x9 cm	-	5,0 t	0,8 kg
Level System Magnum	50x20x9 cm	-	8,0 t	1,3 kg
Level System Jumbo	60x26x12 cm	-	12,0 t	2,9 kg

 ADD TO YOUR LEVELS
**CHOCK LEVEL**

Pair of 2 grey chocks to secure the wheels during long stopovers.

**LEVEL BAG / LEVEL BAG S**

Bag available in washable polyester, helps to keep the vehicle clean.

**ANTI SLIP PLATE**

Optional anti-slip plate for paved surfaces.

**LEVEL PLATE**

Anti-skid system, installed under the Fiamma Level Up to increase its traction, avoiding skidding on smooth surfaces and sinking into soft grounds.



Levelling systems

To complete your safety and that of your vehicle at best.

- resistant material
- easy to transport and lightweight



GRIP SYSTEM

Anti-skid system with superior traction, to be placed under the driving wheels of the motorhome. They can be combined in length for a greater traction surface.



WHEEL SAVER

System of cradles that avoids ovalisation of the tyres, suitable for wheels up to 70 cm in diameter. Ideal in case of long parking and storage of motorhomes and caravans.



ALU JACKS

Polished aluminium jack. Package of 4 stacked pieces during transport. Adjustable in height from min. 28 cm to max. 43 cm.



Wheel & Grip



Jacks



Anti-sinking bases



PLASTIC JACKS

Plastic UV-resistant jacks. Package of 4 stacked pieces during transport. Adjustable in height from min. 31 cm to max. 44 cm.



PLATES PRO

Kit of four anti-sinking bases supplied with four locks to be fastened to the vehicle's lifting jacks.



PLATES

Kit of four highly reinforced anti-sinking plates. Also ideal for use with jacks or with the caravan's A-frame leg.

☰ CHOOSE THE MODEL THAT SUITS YOU

	Weight each
Grip System	0,4 kg
Wheel Saver	0,6 kg
Alu Jacks	0,9 kg
Plastic Jacks	0,8 kg
Plates Pro	0,2 kg
Plates	0,2 kg

For more technical and commercial information, see page 185

+ COMPLETE YOUR VEHICLE WITH



STEP

Step for caravans and motorhomes, made of UV-resistant HD polyethylene for more stability and strength. Anti-skid surface.



STEP-MAT

Covering for the surface of Fiamma Steps. Made of soft and flexible anti-skid UV-resistant rubber.



STEP MAGNUM

Stronger and larger step made of UV-resistant polypropylene. Anti-skid surface.



CLEAN STEP

Convenient doormat to be placed on the electric or manual steps of motorhomes and caravans. Also ideal for double steps.



For more technical and commercial information, see page 186

Organizer

With the Fiamma organizer line, you can best organize the space inside and outside the vehicle.

- many models
- easy to install



Organizer containers



Pack Waste



Carry-Dog



Pack Organizer Box



PACK ORGANIZER L

Dimensions: 88x39 cm
Number of pockets: 6



PACK ORGANIZER S

Dimensions: 50x84 cm
Number of pockets: 11



PACK ORGANIZER TOILETRY

Dimensions: 30x37x11 cm
Number of pockets: 10



PACK ORGANIZER SEAT

Dimensions: 43x66x2 cm
Number of pockets: 4



PACK ORGANIZER SHOES

Dimensions: 84x54x2 cm
Number of pockets: 10



PACK WASTE

Folding dustbin, complete with 2 Fix Organizers and 2 removable hooks for easy fixing.
Dimensions: 29,5x29,5x42 cm



CARRY-DOG

Folding dog house, complete with bag and handle for easy transportation, carpet and eyelets to fasten it to the ground. Side windows with mosquito net which can be rolled up with Velcro.
Dimensions: 75x55x49 cm



PACK ORGANIZER BOX

Dimensions: 60x36x31 cm



FIX ORGANIZER

Dimensions: 5,5x3x1 cm

CHOOSE THE MODEL THAT SUITS YOU

For more technical and commercial information, see page 186

	Dimensions when open	Dimensions when closed	Number of pockets	Weight
Pack Organizer L	88x39 cm	-	6	0,5 kg
Pack Organizer S	50x84 cm	-	11	0,4 kg
Pack Organizer Toiletry	30x37x11 cm	30x118x11 cm	10	0,6 kg
Pack Organizer Seat	43x66x2 cm	-	4	0,3 kg
Pack Organizer Shoes	84x54x2 cm	-	10	1,1 kg
Fix Organizer	5,5x3x1 cm	-	-	0,1 kg
Pack Waste	29,5x29,5x42 cm	29,5x29,5x4,2 cm	-	0,7 kg
Carry-Dog	75x55x49 cm	75x55x4 cm	-	2,8 kg
Pack Organizer Box	60x36x31 cm	60x36x6 cm	-	2,8 kg



Pocket

Multipurpose pockets to organize your space in the best possible way and always have everything in order.

- different dimensions available
- easy to install



Pocket

new
20
21



POCKET PLUS M

new
20
21



POCKET PLUS L



POCKET M



POCKET L



POCKET XL

☰ CHOOSE THE MODEL THAT SUITS YOU

For more technical and commercial information, see page 187

	Colour	Dimensions	Weight
Pocket Plus M [New]	grey	26x8,5x9 cm	0,1 kg
Pocket Plus L [New]	grey	38x11,5x14 cm	0,4 kg
Pocket M	white	26x8,5x8 cm	0,1 kg
Pocket L	white	26x16,5x8 cm	0,1 kg
Pocket XL	grey	38x16x10 cm	0,3 kg

Ultra-Box



Ultra-Box

Large roof boxes for your motorhome.

- material: ABS
- reinforced aluminium structure
- watertight foam seal
- complete with installation brackets and stainless steel hinges



ULTRA-BOX 2

ULTRA-BOX 3



CHOOSE THE MODEL THAT SUITS YOU

	Volume	External dimensions	Internal dimensions	Weight
Ultra-Box 2	400 l	120x91x42 cm	107,5x77,5x37,5 cm	13 kg
Ultra-Box 3	520 l	170x91x42 cm	155x77,5x37,5 cm	17 kg

For more technical and commercial information, see page 187



Fixing-Bar

Range of accessories to best organise the roof of your motorhome.

- adaptable to different types of vehicles
- easy to install



Luggage carrier system & carry-all bars



Roof racks accessories

CHOOSE THE MODEL THAT SUITS YOU

	Weight
Roof Rail	4,7 kg
Fixing-Bar Rail	3,4 kg
Fixing-Bar Pro L	1,5 kg
Roller Roof Rail	1,5 kg

For more technical and commercial information, see page 187



ROOF RAIL

Two longitudinal bars that can be shortened, easy to install on the roofs of motorhomes and caravans. The anodised aluminium tubes are suitable for quick attachment of the optional Fixing-Bar Rail.



FIXING-BAR PRO L

Roof rail in extruded aluminium, easily to shorten. To be placed on the camper or caravan roof. Ideal supporting system for solar panels or roof boxes.



FIXING-BAR RAIL

Roof rails in anodised aluminium. Easily combinable with the Roof Rail without drilling the vehicle, easily shortened.



ROLLER ROOF RAIL

Roller for loading the roof rack. Facilitates the loading of canoes, kayaks and other objects from the rear of the vehicle. Ideal to be used with Roof Rail Ducato, Roof Rail Ducato Maxi XL.

Roof Rail Ducato

To make the most of your vehicle's roof, a complete roof rack system for Fiat Ducato, Citroën Jumper and Peugeot Boxer.

- Installation without drilling the vehicle.
- Versions for lengths from L1 to L4
- Specific version for H3 vehicles
- Two finishes: aluminium and Deep-Black

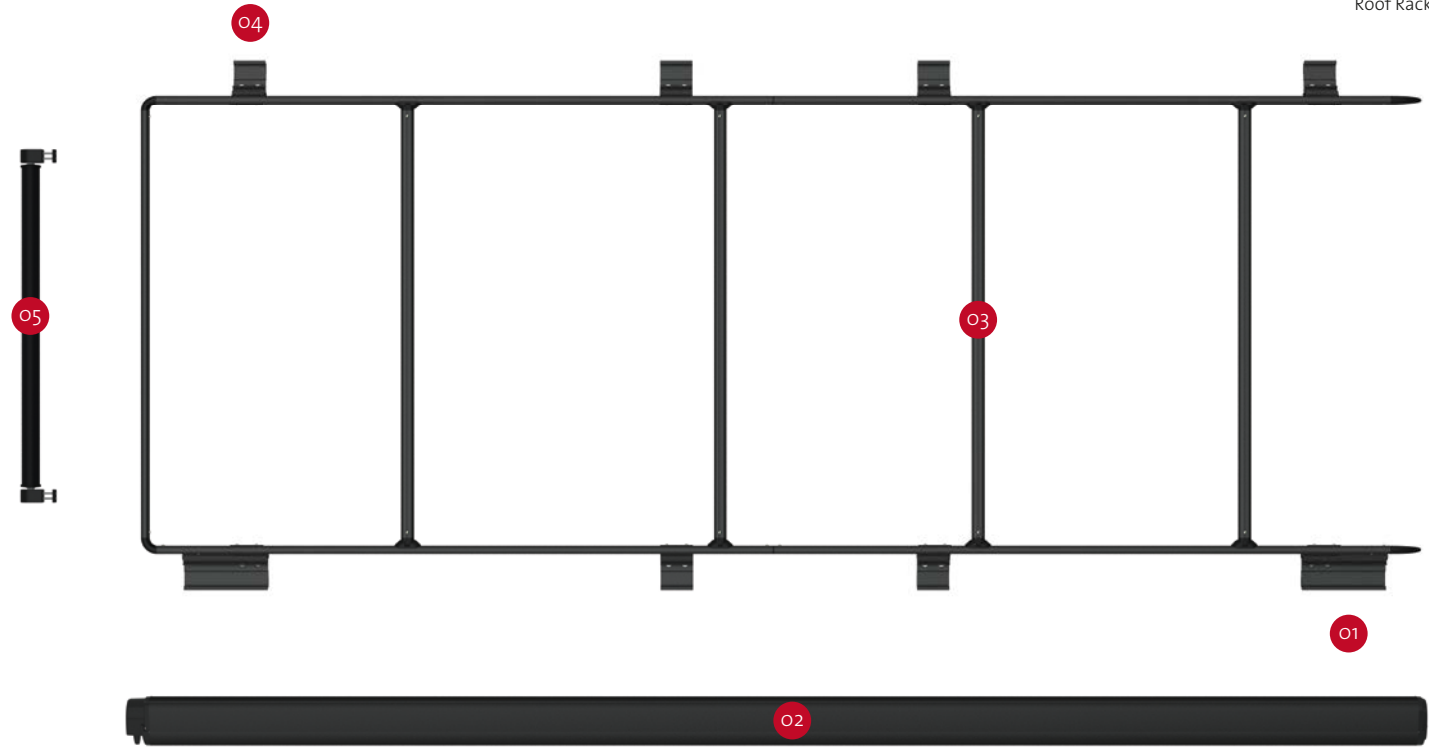

Ducato
Roof Racks

01 Brackets F80s / F65s
Supplied as standard.
To mount the awning
without drilling the vehicle.

03 Two finishes
Available in two finishes:
aluminium and DeepBlack

02 F80s
Roof awning
(to be purchased separately)
It is ideal to combine with
Ducato Roof Rail

04 Covers
Optional accessory kit
to cover the mounting
brackets

05 Roller Roof Rail
Add it to the Roof Rail.
It will be a convenient aid
in loading operations.

CHOOSE THE MODEL THAT SUITS YOU

For more technical and commercial information, see page 187

	Weight		Weight
Roof Rail Ducato	12,0 kg	Roller Roof Rail	1,5 kg
Roof Rail Ducato Deep Black [New]	12,0 kg	Kit Roof Rail Ducato Extra	1,0 kg
Roof Rail Ducato Maxi XL	13,5 kg	Kit Roof Rail Ducato Cover Left [New]	0,1 kg
Roof Rail Ducato H3	0,1 kg	Kit Roof Rail Ducato Cover Right [New]	0,1 kg
		Kit Roof Rail Ducato Extra Cover [New]	0,1 kg

Garage

Multipurpose shelving and bar system to organise your garage.

- suitable for all models of motorhomes
- made of light and strong aluminium



Shelves



Bars



GARAGE BOX

Set of three folding boxes suitable for the shelves of the Garage System; folded down they take up little space.



GARAGE SYSTEM STANDARD

Single stand with three shelves to position the optional folding boxes or to put all the goods of the camper away tidily in the camper storage compartment.

Adjustable in height and with section bars that can be shortened in case of rear steps or narrow, curved spaces.



GARAGE WALL BRACKETS KIT

Optional kit for wall installation or installation on the side bars Garage-Bars for garage with adjustable roof height.



GARAGE SYSTEM UPGRADE

To enlarge the standard module with a second shelf.



GARAGE BARS

Multipurpose aluminium bars to be applied to garage walls or floors. Four versions available:

- Garage Bars
- Garage Bars Corner
- Garage Bars Premium 200
- Garage Bars Premium 60

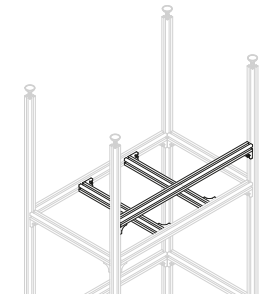

GARAGE SYSTEM SUPPORT

Set of two lower bars and one side aluminium bar to be used as a support for the Garage System for greater support and fixing.



SQUARE PLATES KIT

Corrosion-proof stainless steel hooks to be applied to the floor or walls of the garage.



LUGGAGE BAR

Telescopic bar ideal for easily and safely fastening your objects into the storage compartments or dinette of the vehicle while travelling.



GARAGE CARRY-RAIL

The clothes rack is composed of a sturdy light tubular bar in anodized aluminium, supported by two strong ceiling fixings.

CHOOSE THE PRODUCT THAT SUITS YOU

	Weight		Weight
Garage System Standard	5,7 kg	Garage Bars	3,1 kg
Garage System Upgrade	3,9 kg	Garage Bars Corner	4,8 kg
Garage System Support	0,9 kg	Garage Bars Premium 200	4,8 kg
Garage Box	5,6 kg	Garage Bars Premium 60	2,2 kg
Kit Garage Wall Brackets	0,1 kg	Kit Square Plates	0,1 kg

For more technical and commercial information, see page 188

ACCESSORIES

For more technical and commercial information, see page 188



EYE PREMIUM/CORNER KIT

Additional hooks for Premium Eye Kit/Corner.



EYE KIT

Additional hooks for Eye Kit



CARGO STRAP

To block objects such as small tables, chairs, spare wheels in the storage compartment or in the garage of your motorhome.



CARGO ACCESSORY KIT

Optional kit in combination with Cargo Strap.

Safe Door

To make your journey even safer, a wide range of safety blocks.

- suitable for campers and caravans (Safe Door Guardian for van conversions)
- easy to install
- 3 colours available for Safe Door and Safe Door Frame: white, grey and black
- Safe Door Magnum and Safe Door Magnum Frame available in white



SAFE DOOR GUARDIAN

Made of sturdy aluminium, without plastic parts. It is installed in place of the standard weak plastic blocks in the living unit, in the same position and using the same fixing holes. Versions for Ducato and Transit are available as well.



SAFE DOOR

Made of sturdy painted aluminium, without plastic parts. Convenient anti-theft alarm also for storage compartments and garage doors. Wall fixing with 4 through screws.



SAFE DOOR FRAME

Made of sturdy painted aluminium, without plastic parts. Ideal for installation on the internal profiles of motorhome and caravan doors with 3 self-threading screws.



Safe Door Guardian



Safe Door



new
20
21

SAFE DOOR MAGNUM

Length extended to 20 cm in order to cover, where possible, the locks of the motorhome doors, for greater protection against theft.



new
20
21

SAFE DOOR MAGNUM FRAME

Fixing on the internal profiles of the doors with 3 self-threading screws and length extended to 20 cm to cover, where possible, the locks of the doors.



DUO SAFE PRO

Security system to keep the vehicle cabin doors closed from the inside.

 CHOOSE THE MODEL THAT SUITS YOU

	Colours	Weight
Safe Door Guardian	aluminium	0,4 kg
Safe Door	white - grey - black	0,6 kg
Safe Door 3 *	white - grey - black	1,7 kg
Safe Door Frame	white - grey - black	0,5 kg
Safe Door Frame 3 *	white - grey - black	1,5 kg
Safe Door Magnum [New]	white	0,6 kg
Safe Door Magnum Frame [New]	white	0,6 kg
Duo-Safe Pro	grey	1,0 kg

For more technical and commercial information, see page 189

* One Key System

Version "3" works with the One Key System: it is composed of three pieces of Safe Door or Safe Door Frame with locks using the same key.

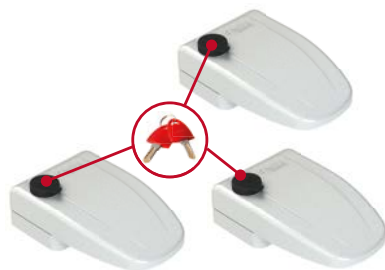
 ACCESSORIES

For more technical and commercial information, see page 189

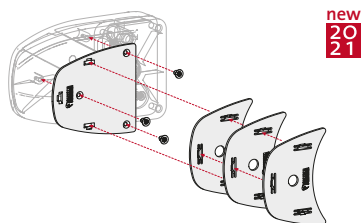

SPACER SAFE DOOR WHITE KIT >2017

Kit of spacers to reduce the space between Safe Door lock and wall, to adapt it to the shape of the Safe Door family.

Available in colours: white, grey and black.



Security

Security handles to help you get in and out of the vehicle.

- foldable against the wall
- suitable for both right and left opening of doors
- equipped with non-slip grip



Security



SECURITY 31

Security handle made of painted aluminium, Ø 30 mm and thickness 2 mm. Height 31 cm.



SECURITY 46

Security handle made of painted aluminium, Ø 30 mm and thickness 2 mm. Height 46 cm.



SECURITY 46 PRO

Specially designed for applications where a high solidity structure is required. Complete with Security Lock Kit for greater security and solidity thanks to the third fixing point on the door.



SECURITY 5

Length extended to 20 cm in order to cover, where possible, the locks of the motorhome doors, for greater protection against theft.

☰ CHOOSE THE MODEL THAT SUITS YOU

For more technical and commercial information, see page 190

	Colours	Weight
Security 31	white	1.1 kg
Security 46	white	1.2 kg
Security 46 Pro	white	1.7 kg
Security 46 S	white	1.1 kg

+ ACCESSORIES

For more technical and commercial information, see page 190



SPACER SECURITY FENDT KIT

Specific spacer kit for mounting the Security handles on Fendt caravans.



SECURITY LOCK KIT

Optional safety lock kit, to be mounted on motorhome doors. Complete with keys and internal brackets.



SECURITY GRIP

Non-slip neoprene cover to protect the Security handles security grip.



Deluxe

Interior and exterior ladders, different models to adapt to your vehicle.

- pipes \varnothing 30 mm and thickness 2 mm
- anodised aluminium
- Non-skid finish
- Step inner width: 28 cm
- Step total width: 35 cm
- Deluxe Dj Ducato, Dj Ducato H3 and Sprinter also available in Deep Black version



Outdoor ladders



Indoor ladders



DELUXE DJ DUCATO

Ladder with 6 steps.
Installation with Fixing Bar on the left door of the vehicle.
Combines a Carry-Bike mounted on the right door.



DELUXE DJ DUCATO H3

Ladder with 6 steps.
Specific version for vehicles with height H3.



DELUXE SPRINTER

Ladder with 8 steps and folding up structure. Installation with Fixing Bar on the left door of the vehicle.
To install the Carry-Bike on the right door.



DELUXE 8

Ladder with 8 steps and folding up structure. Ideal for the rear wall of the motorhome



DELUXE 5D

Ladder with 10 steps and folding up structure. Ideal for the rear wall of the motorhome



SAFE LADDER

Reinforced safety plate.
Anti-theft plate for ladder.
Suitable for single fixed ladders or folding ladders. Complete with knob and key

**DELUXE 4B**

Equipped with 15° inclined steps for the inside of the overcab motorhome or for caravans with sleeping berths. Height: 150 cm

**DELUXE 5B**

Equipped with 15° inclined steps for the inside of the overcab motorhome or for caravans with sleeping berths. Height: 165 cm

CHOOSE THE MODEL THAT SUITS YOU

For more technical and commercial information, see page 190

	Finish	Environment	Weight
Deluxe DJ Ducato	Aluminium - Deep Black	exterior	6,5 kg
Deluxe DJ Ducato H3	Aluminium - Deep Black	exterior	6,9 kg
Deluxe Sprinter	Aluminium - Deep Black	exterior	7,0 kg
Deluxe 8	Aluminium	exterior	5,5 kg
Deluxe 5D	Aluminium	exterior	4,9 kg
Safe Ladder	-	exterior	1,3 kg
Deluxe 4B	Aluminium	interior	2,4 kg
Deluxe 5B	Aluminium	interior	2,6 kg



Bi-Pot

Portable toilets and sanitary accessories.

- scratch-resistant tanks
- handy drain openings
- easy to clean
- comfortable and wide seat
- available in 3 sizes



Bi-Pot



Sanitary accessories



SMALL

BI-POT 30

Upper tank capacity: 10 l
Lower tank capacity: 11 l



MEDIUM

BI-POT 34

Upper tank capacity: 15 l
Lower tank capacity: 13 l



LARGE

BI-POT 39

Upper tank capacity: 15 l
Lower tank capacity: 20 l



SUPER KEM BLUE

Detergent for fixed and portable toilets. It accelerates disintegration, limiting the formation of unpleasant gases and odours even at high temperatures.



SUPER KEM SACHETS

Powder disintegrating, deodorising and sanitising detergent in sachets for daily use, individually packed in protective packaging.



SUPER RINSE

For fresh water tanks of portable or fixed toilets. Scented bactericide for chemical toilets.



POCKET KASSETT

Composed of four storage pockets for storing Super Kem Sachets in powder and various materials. It is fixed with the standard screws inside the door of the Thetford or Dometic Kassett of the vehicle.



DISPENSER

Soap or liquid shampoo dispenser (100 doses), refillable, 0.20 l, with transparent container.



SOFT 6

Special two-ply toilet paper specially designed for fixed and portable toilets. Pack of 6 rolls, 300 sheets.



TOILET BRUSH PRO

Compact toilet brush holder for WC, takes up very little space in the corner of the bathroom.



TOILET BRUSH

Equipped with Velcro to be applied also to the internal cover of the Bi-Pot.



BIDET

Universal bidet for all types of Bi-Pot. Thetford Porta Potti, Cassette 1, 2, 3 and 4.

Bidet 200 for Thetford Cassette 200 swivelling, C250 and Dometic CT3000.

CHOOSE THE MODEL THAT SUITS YOU

	Upper tank	Lower tank	Weight
Bi-Pot 30	10 l	11 l	4,0 kg
Bi-Pot 34	15 l	13 l	4,6 kg
Bi-Pot 39	15 l	20 l	4,6 kg

	Weight		Weight
Super Kem Blue	2,0 kg	Soft 6	0,7 kg
Super Kem Sachets	0,5 kg	Toilet Brush Pro	0,2 kg
Super Rinse	0,7 kg	Toilet Brush	0,1 kg
Pocket Kassett	0,2 kg	Bidet Universal	0,3 kg
Dispenser	0,2 kg	Bidet 200	0,3 kg

For more technical and commercial information, see page 191

Vehicle covers

Covers to protect your vehicle from weather, dust, pollution and dirt.

- perfect adherence to the vehicle
- resistant material
- different models for each type of vehicle



Motorhome cover



Covers for camper vans and van conversions

CHOOSE THE MODEL THAT SUITS YOU

	Weight
Cover Top	6,0 kg
Thermoglas XXL Ducato	11,0 kg
Thermoglas Ducato Windscreen	5,0 kg
Coverglas XL Ducato	3,5 kg
Coverglas VW T5/T6	3,5 kg
Coverglas Ford Transit	3,5 kg
Thermo Wall Ducato Cabin	1,8 kg

For more technical and commercial information, see page 191



COVER TOP

Made of UV-resistant fabric vinyl, easy to tension with ropes or elastic cords, reinforced corners and tie down grommets.
Dimensions: 8.5x5.2 m.



COVERGLAS

Exterior blind to protect the cabin from sun and UV rays. For Ducato > 2006, VW T5/T6, Ford Transit.



THERMOGLAS XXL DUCATO

Designed for Fiat Ducato, Citroën Jumper and Peugeot Boxer > 2006. Ideal for winter use to completely cover the engine compartment; insulated material suitable for low temperatures. Available in the complete model and "Windscreen" model with only the upper part.



THERMO WALL DUCATO CABIN

Convenient and useful thermal panel to be put between the cabin and the motorhome of Fiat Ducato, Citroën Jumper and Peugeot Boxer chassis after 06/2006.

COVER PREMIUM

Cover for the motorhome, with belt tension system for excellent adherence.

Available in two versions:

- M: for motorhomes up to 7,1 m.

Dimensions: m 7,16 x 2,59 x 2,74 h

- L: for motorhomes up to 8 m.

Dimensions: m 8,08 x 2,59 x 2,74 h



01



4 plastic buckles to fix the lower part

02



Maximum ventilation thanks to the air vents that also prevent condensation of water under the canopy

04



6 convenient hinges (3 per side) allow entry into the vehicle on both sides

03



Velcro for fixing the side panels when they are fully open

05



Locking system with sturdy plastic buckles. Reflective strips increase visibility during storage

CHOOSE THE MODEL THAT SUITS YOU

	Dimensions	Weight
Cover Premium M (up to 7,1 m)	m 7,16 x 2,59 x 2,74h	10,0 kg
Cover Premium L (up to 8 m)	m 8,08 x 2,59 x 2,74h	11,0 kg

For more technical and commercial information, see page 191



Various accessories

To complete your Comfort range.



Various accessories

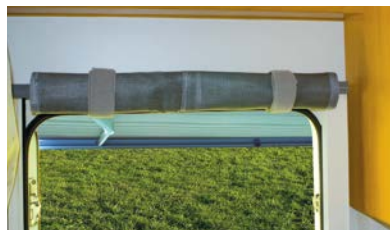

MOSKITO NET / NET PRO

Moskito Net Pro: mosquito net which also acts as a shade panel blocking about 60% of the light. Composed of 2 overlapping panels. Dimensions: 52x230 cm.

Moskito Net: mosquito net composed of 2 overlapping panels. Dimensions: 35x230 cm.



DRIP STOP

Mini-gutter to eliminate black streaks on your motorhome, caravan and vans.

Available in white, grey and black.



MUD FLAP

Rubber mud flaps with painted steel bracket.

Mud Flap Front: behind the front wheels of the Ducato after 2006.

Mud Flap Rear: installation in the rear panel of the motorhome.



DOOR HOLDER

External plastic door holder, to prevent unintentional closing.



OMNI STOP

Multipurpose accessory to keep plates and items in place in the motorhome as you travel.



TABLE LEGS

Modular table leg system, ideal to build removable and revolving tables.

☰ CHOOSE THE PRODUCT THAT SUITS YOU For more technical and commercial information, see page 192

	Weight		Weight		Weight
Moskito Net Pro	0,6 kg	Drip Stop 75	0,2 kg	Mud Flap Front	1,2 kg
Moskito Net	0,5 kg	Drip Stop 300	0,8 kg	Mud Flap Rear	1,2 kg
Door Holder	0,1 kg	Drip Stop 1000	2,5 kg		
Omni Stop	0,1 kg				

☰ HOW TO COMPOSE TABLE LEGS For more technical and commercial information, see page 192

	Weight		Weight
Tube Pro (A)	0,6 kg	Recessed Connection (D)	0,8 kg
Tripod Pro (B)	0,5 kg	Cap (E)	2,5 kg
Conic Connection (C)	0,2 kg	Adapter Tube Pro (F)	1,2 kg

A Tube Pro
Table leg tube

B Tripod Pro
Reinforced tripod

C Conic Connection
Conical connections

D Recessed Connection
Recessed conical connections

E Cap
Table leg tube

F Adapter Tube Pro
To store the tube pro



F45s

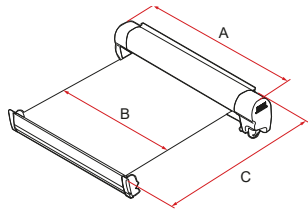
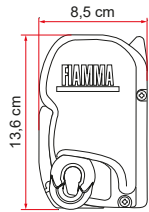

Description	Case finishes	Fabric colours	Length (A)	Length (B)	Extension (C)	Shade surface	Item No.
F45s 190*	Polar White	R-Q	185 cm	169 cm	100 cm	1,7 m ²	06280Mo1(X)
F45s 230			231 cm	214 cm	150 cm	3,2 m ²	06280Po1(X)
F45s 260		R-Q-S-E-D	263 cm	247 cm	200 cm	4,9 m ²	06280Ho1(X)
F45s 300			308 cm	292 cm	250 cm	7,3 m ²	06280Ao1(X)
F45s 350			348 cm	331 cm		8,3 m ²	06280Bo1(X)
F45s 375			R-Q	375 cm		357 cm	8,9 m ²
F45s 400**		R-Q-S-E-D	398 cm	381 cm		9,5 m ²	06280Co1(X)
F45s 425**		R-Q	423 cm	405 cm	10,1 m ²	06280Qo1(X)	
F45s 450**		R-Q-S-E-D	448 cm	431 cm	10,8 m ²	06280Go1(X)	
F45s 190*		Titanium	R-Q	185 cm	169 cm	100 cm	1,7 m ²
F45s 230	231 cm			214 cm	150 cm	3,2 m ²	06290Po1(X)
F45s 260	263 cm			247 cm	200 cm	4,9 m ²	06290Ho1(X)
F45s 300	308 cm			292 cm	250 cm	7,3 m ²	06290Ao1(X)
F45s 350	348 cm			331 cm		8,3 m ²	06290Bo1(X)
F45s 375	375 cm			357 cm		8,9 m ²	06290So1(X)
F45s 400**	398 cm			381 cm		9,5 m ²	06290Co1(X)
F45s 425**	423 cm			405 cm	10,1 m ²	06290Qo1(X)	
F45s 450**	448 cm			431 cm	10,8 m ²	06290Go1(X)	
F45s 190*	Deep Black			R	185 cm	169 cm	100 cm
F45s 230		231 cm	214 cm		150 cm	3,2 m ²	06759Po1R
F45s 260		263 cm	247 cm		200 cm	4,9 m ²	06759Ho1R
F45s 300		308 cm	292 cm		250 cm	7,3 m ²	06759Ao1R
F45s 350		348 cm	331 cm			8,3 m ²	06759Bo1R
F45s 375		375 cm	357 cm			8,9 m ²	06759So1R
F45s 400**		398 cm	381 cm			9,5 m ²	06759Co1R
F45s 425**		423 cm	405 cm		10,1 m ²	06759Qo1R	
F45s 450**		448 cm	431 cm		10,8 m ²	06759Go1R	

* Awning for the main door, comes without vertical support legs. ** 1 Tension Rafter made of anodized aluminium included.
Specify the fabric colour you want when ordering by replacing (X) with: R=Royal Grey, Q=Royal Blue, S=Sahara, E=Evergreen, D=Bordeaux
For RHD vehicles available on request the left version awning with winch installed on the left side, case in Polar White and canopy in Royal Grey

F45s campervan

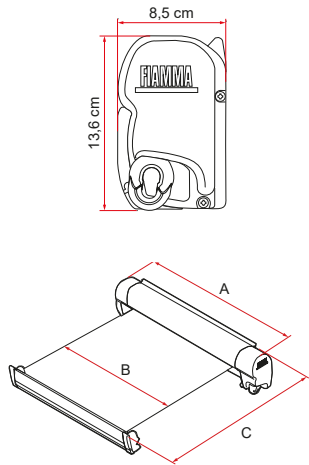

Description	Case finishes	Fabric colours	Length (A)	Length (B)	Extension (C)	Shade surface	Item No.
F45s 260 VW T5/T6 California	Polar White	Royal Grey	263 cm	247 cm	200 cm	4,9 m ²	o628oEo1R
F45s 260 VW T5/T6 M / T	Titanium	Royal Grey	263 cm	247 cm	200 cm	4,9 m ²	o629oDo1R
F45s 260 VW T5/T6 M / T - RHD			263 cm	247 cm			o6291Do1R
F45s 260 VW T5/T6 California			263 cm	247 cm			o629oEo1R
F45s 300 VW T5/T6 M / T - Long			308 cm	292 cm		5,8 m ²	o629oRo1R
F45s 300 VW T5/T6 M / T - Long - RHD			308 cm	292 cm			o6291Ro1R
F45s 260 VW T5/T6 M / T			Deep Black	Royal Grey		263 cm	247 cm
F45s 260 VW T5/T6 M / T - RHD	263 cm	247 cm			o7129Do2R		
F45s 260 VW T5/T6 California	263 cm	247 cm			o6759Eo1R		
F45s 300 VW T5/T6 M / T - Long	308 cm	292 cm			5,8 m ²	o6759Ro1R	
F45s 260 VW T5/T6 M / T - Long - RHD	308 cm	292 cm				o7129Ro2R	

The F45s VW T5/T6 Multivan, Transporter and California are delivered as standard with installation kit, consisting of 2 brackets. No drilling of the vehicle required.
 RHD = Special version with winch on the left side, preset for Right Hand Drive vehicles (UK). ** Installation Kit, delivered as standard, is in Deep Black finish like the awning
 M: Multivan T: Transporter C: California Long = long wheel base

F45L

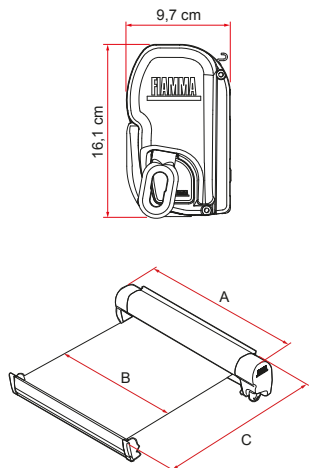

Description	Case finishes	Fabric colours	Length (A)	Length (B)	Extension (C)	Shade surface	Item No.
F45s 260 PSA	Polar White	Royal Grey	263 cm	247 cm	200 cm	4,9 m ²	o628oFo1R
F45s 260 PSA	Deep Black		263 cm	247 cm	200 cm	4,9 m ²	o6759Fo1R

Description	Case finishes	Fabric colours	Length (A)	Length (B)	Extension (C)	Shade surface	Item No.
F45L 450	Polar White	R-Q-S-E-D	452 cm	435 cm	250 cm	10,9 m ²	o653o-01(X)
F45L 500			502 cm	485 cm		12 m ²	o653oA01(X)
F45L 550			552 cm	535 cm		13,3 m ²	o653oB01(X)
F45L 450	Titanium	R-Q	452 cm	435 cm	250 cm	10,9 m ²	o6532-01(X)
F45L 500			502 cm	485 cm		12 m ²	o6532A01(X)
F45L 550			552 cm	535 cm		13,3 m ²	o6532B01(X)

1 Tension Rafter included, made of anodized aluminium.
 Specify the fabric colour you want when ordering by replacing (X) with: R=Royal Grey, Q=Royal Blue, S=Sahara, E=Evergreen, D=Bordeaux

F45eagle

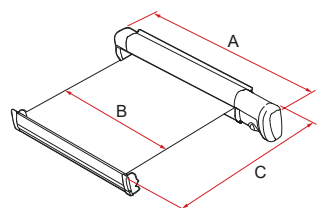
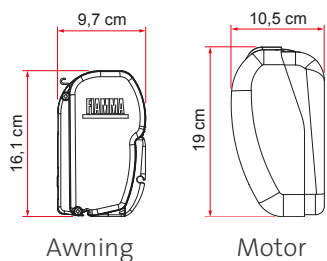

Description	Case finishes	Fabric colours	Length (A)	Length (B)	Extension (C)	Shade surface	Item No.
F45eagle 350	Polar White	Royal Grey	366 cm	335 cm	250 cm	8,3 m ²	06472-01R
F45eagle 400			416 cm	385 cm		9,6 m ²	06472A01R
F45eagle 450			466 cm	435 cm		11 m ²	06472B01R

Important: verify with your trusted dealer if your motorhome or motorcaravan is suitable for the installation of the F45eagle with sturdy full length aluminium bracket. The vehicle must be robust enough to support the weight and the tension of the open awning. Fiamma refuses all responsibility for damages to the walls or for water ingress due to incorrect installation or due to installations on weak walls

SLIDEOUT

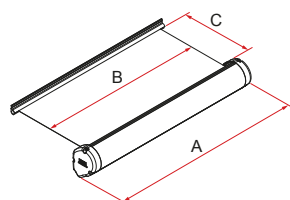
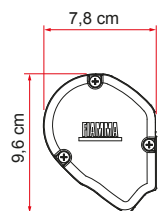

Description	Case finishes	Fabric colour	Length (A)	Length (B)	Extension (C)	Shade surface	Item No.
SlideOut 170	Polar White	Royal Grey	168 cm	162 cm	100 cm	1,6 m ²	06902-01R
SlideOut 200			198 cm	192 cm		1,9 m ²	06902B01R
SlideOut 280			278 cm	272 cm		2,7 m ²	06902D01R
SlideOut 170	Deep Black	Royal Grey	168 cm	162 cm	100 cm	1,6 m ²	07158-01R
SlideOut 200			198 cm	192 cm		1,9 m ²	07158B01R
SlideOut 280			278 cm	272 cm		2,7 m ²	07158D01R

The awning is delivered as standard with installation brackets, not equipped with legs and arms, exclusively designed for slide out walls.

F80s

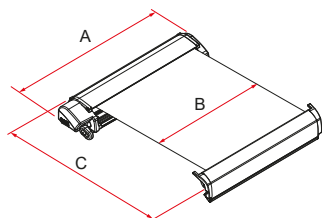
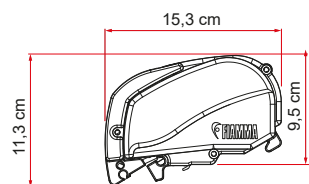

Description	Case finishes	Fabric colours	Length (A)	Length (B)	Extension (C)	Shade surface	Item No.
F80s 290	Polar White	R-Q	290 cm	278 cm	200 cm	5,6 m ²	07830A01(X)
F80s 320			320 cm	308 cm	250 cm	7,7 m ²	07830B01(X)
F80s 340			340 cm	328 cm		8,2 m ²	07830C01(X)
F80s 370			370 cm	358 cm		9,0 m ²	07830D01(X)
F80s 400 *			400 cm	388 cm		9,7 m ²	07830E01(X)
F80s 425 *			425 cm	412 cm		10,3 m ²	07830F01(X)
F80s 450 *			450 cm	431 cm		10,8 m ²	07830G01(X)
F80s 290	Titanium	R-Q	290 cm	278 cm		200 cm	5,6 m ²
F80s 320			320 cm	308 cm	250 cm	7,7 m ²	07832B01(X)
F80s 340			340 cm	328 cm		8,2 m ²	07832C01(X)
F80s 370			370 cm	358 cm		9,0 m ²	07832D01(X)
F80s 400 *			400 cm	388 cm		9,7 m ²	07832E01(X)
F80s 425 *			425 cm	412 cm		10,3 m ²	07832F01(X)
F80s 450 *			450 cm	431 cm		10,8 m ²	07832G01(X)
F80s 290	Deep Black	R	290 cm	278 cm		200 cm	5,6 m ²
F80s 320			320 cm	308 cm	250 cm	7,7 m ²	07831B01R
F80s 340			340 cm	328 cm		8,2 m ²	07831C01R
F80s 370			370 cm	358 cm		9,0 m ²	07831D01R
F80s 400 *			400 cm	388 cm		9,7 m ²	07831E01R
F80s 425 *			425 cm	412 cm		10,3 m ²	07831F01R
F80s 450 *			450 cm	431 cm		10,8 m ²	07831G01R

* 1 Rafter in alluminio incluso.

Specify the fabric colour you want when ordering by replacing (X) with: R=Royal Grey, Q=Royal Blue

F65L

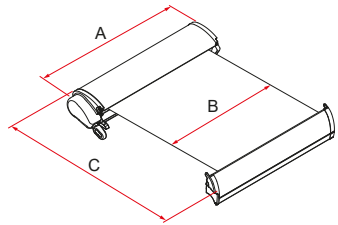
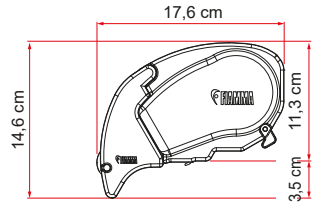

Description	Case finishes	Fabric colours	Length (A)	Length (B)	Extension (C)	Shade surface	Item No.
F65L 400	Polar White	R-Q	400 cm	380 cm	250 cm	9,5 m ²	07715Co1(X)
F65L 450			450 cm	430 cm		10,8 m ²	07715Do1(X)
F65L 490			490 cm	470 cm		11,8 m ²	07715Eo1(X)
F65L 400	Titanium	R-Q	400 cm	380 cm	250 cm	9,5 m ²	07716Co1(X)
F65L 450			450 cm	430 cm		10,8 m ²	07716Do1(X)
F65L 490			490 cm	470 cm		11,8 m ²	07716Eo1(X)
F65L 400	Deep Black	R-Q	400 cm	380 cm	250 cm	9,5 m ²	07717Co1(X)
F65L 450			450 cm	430 cm		10,8 m ²	07717Do1(X)
F65L 490			490 cm	470 cm		11,8 m ²	07717Eo1(X)

1 Rafter in alluminio incluso.

Specify the fabric colour you want when ordering by replacing (X) with: R=Royal Grey, Q=Royal Blue

F65eagle

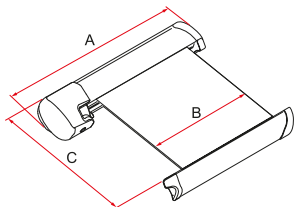
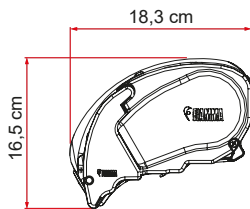

Description	Case finishes	Fabric colours	Length (A)	Length (B)	Extension (C)	Shade surface	Item No.
F65eagle 400	Polar White	Royal Grey	420 cm	380 cm	250 cm	9,5 m ²	07755Co1R
F65eagle 400	Titanium	Royal Grey	420 cm	380 cm	250 cm	9,5 m ²	07756Co1R
F65eagle Ducato 319	Polar White	Royal Grey	320 cm	285 cm	250 cm	7,2 m ²	07755Fo1R
F65eagle Ducato 369	Polar White	Royal Grey	370 cm	335 cm	250 cm	8,3 m ²	07755Go1R
F65eagle Ducato 399	Polar White	Royal Grey	405 cm	369 cm	250 cm	9,2 m ²	07755Ho1R

Important: verify with your trusted dealer if your motorhome or motorcaravan is suitable for the installation of the F65eagle. The vehicle must be robust enough to support the weight and the tension of the open awning. Fiamma refuses all responsibility for damages to the roofs or for water ingress due to incorrect installation or due to installations on weak roofs

F40van

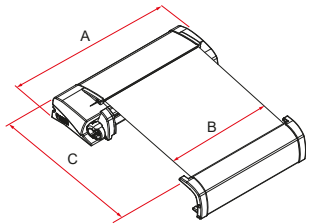
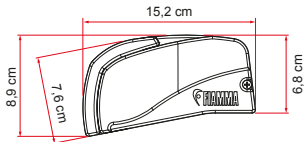

Description	Case finishes	Fabric colours	Length (A)	Length (B)	Extension (C)	Shade surface	Item No.
F40van	Deep Black	Royal Grey	270 cm	257 cm	225 cm	5,8 m ²	07503H01R

CaravanStore / XL

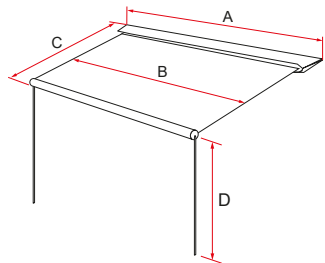
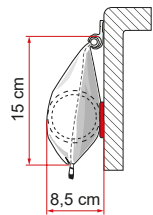

Description	Bag colour	Fabric colours	Length (A)	Length (B)	Extension (C)	Altezza max. da terra (D)	Shade surface	Item No.
CStore 190	grey	R - Q	193 cm	162 cm	180 cm	195 cm	2,9 m ²	06760-01(X)
CStore 225			235 cm	202 cm	225 cm 225 cm	225 cm	4,5 m ²	06760A01(X)
CStore 255			264 cm	232 cm			5,2 m ²	06760B01(X)
CStore XL 280	grey	R - Q	286 cm	254 cm	250 cm	225 cm	6,4 m ²	07740C01(X)
CStore XL 310			316 cm	284 cm			7,1 m ²	07740D01(X)
CStore XL 360			366 cm	334 cm			8,4 m ²	07740E01(X)
CStore XL 410 *			415 cm	384 cm			9,6 m ²	07740F01(X)
CStore XL 440 **			448 cm	414 cm			10,4 m ²	07740G01(X)
CStore XL 500 ***			497 cm	465 cm			11,6 m ²	07740H01(X)
CStore XL 550 ***			547 cm	515 cm			12,9 m ²	07740L01(X)
CStore XL 310 Black	black	R	316 cm	284 cm	250 cm	225 cm	7,1 m ²	07760D01R
CStore XL 360 Black			366 cm	334 cm			8,4 m ²	07760E01R
CStore XL 410 * Black			415 cm	384 cm			9,6 m ²	07760F01R

* 1 tension Rafter CaravanStore included ** 1 tension Rafter CaravanStore and 1 CaravanStore Support Leg included *** 2 CaravanStore Support Leg included
Specify the fabric colour you want when ordering by replacing (X) with: R=Royal Grey, Q=Royal Blue

F35pro

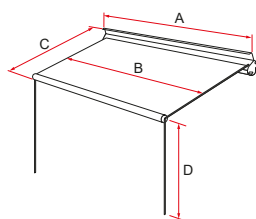
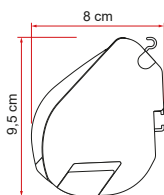

Description	Case finishes	Fabric colours	Length (A)	Length (B)	Extension (C)	Max. Height from ground (D)	Shade surface	Item No.
F35pro 180	Titanium	R-Q	183 cm	162 cm	180 cm	195 cm	2,9 m ²	06762-01(X)
F35pro 220		R-Q	223 cm	202 cm	225 cm	225 cm	4,5 m ²	06762A01(X)
F35pro 250		R-Q	253 cm	232 cm	225 cm	225 cm	5,2 m ²	06762B01(X)
F35pro 270		R-Q	273 cm	254 cm	225 cm	225 cm	5,7 m ²	06762C01(X)
F35pro 300		R-Q	303 cm	282 cm	225 cm	225 cm	6,4 m ²	06762D01(X)
F35pro 250	Deep Black	R	253 cm	232 cm	225 cm	225 cm	5,2 m ²	06458B01R
F35pro 270		R	273 cm	254 cm	225 cm	225 cm	5,7 m ²	06458C01R

Specify the fabric colour you want when ordering by replacing (X) with: R=Royal Grey, Q=Royal Blue

Compass

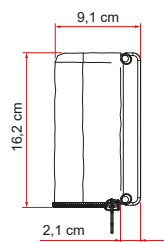
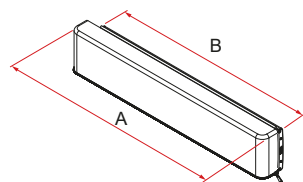

Description	Bag colour (A)	Bag length (A)	Support length (B)	Min height from ground	Item No.
Compass 220	Silver	220 cm	214 cm	200 cm	07260A01J
Compass 260		260 cm	254 cm	200 cm	07260B01J
Compass 220	Black	220 cm	214 cm	200 cm	07261A01J
Compass 260		260 cm	254 cm	200 cm	07261B01J

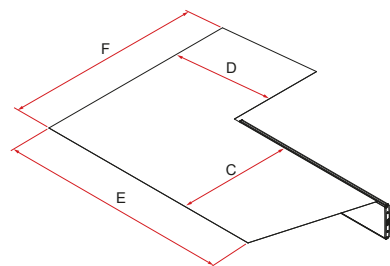

Description	Extension (C)	Extension (D)	Length (E)	Length (F)	Shade surface
Compass 220	148 cm	145 cm	300 cm	336 cm	7,2 m ²
Compass 260	176 cm	173 cm	358 cm	370 cm	9,9 m ²

Installation adapter optionally available.
Bag: Silver or Black - Canopy: Light Grey

Awning accessories

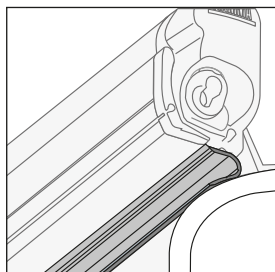

[1] Rain Guard Lower

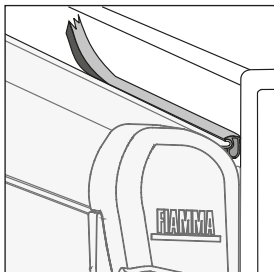

[2] Rain Guard S

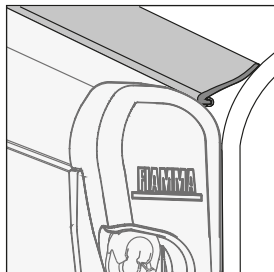

[3] Rain Guard M

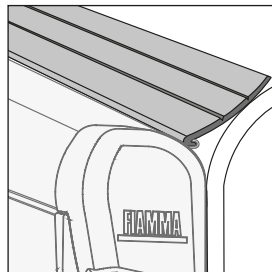

[4] Rain Guard L

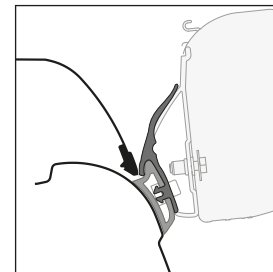

[5] Rain Guard California

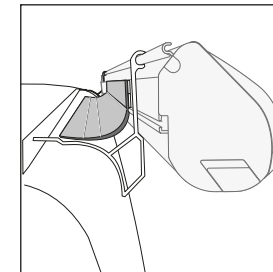

[6] Kit Rain Guard Van

Description	Rail length	Weight	Item No.	In combination with bracket kit:
[1] Rain Guard Lower	Sold by meter	0,35 kg/m	06299-01-	-
[1] Kit Rain Guard Lower 550	550 cm	1,9 kg	98655Z017	-
[2] Rain Guard S	Sold by meter	0,25 kg/m	03910-01-	-
[2] Kit Rain Guard S 550	550 cm	0,8 kg	98655Z014	-
[3] Rain Guard M	Sold by meter	0,25 kg/m	03477-01-	-
[3] Kit Rain Guard M 550	550 cm	1,4 kg	98655Z015	-
[4] Rain Guard L	Sold by meter	0,30 kg/m	04629-01-	-
[4] Kit Rain Guard L 550	550 cm	3,1 kg	98655Z016	-
[5] Kit Rain Guard California	200 cm	0,70 kg	98655-663	-
[6] Kit Rain Guard Van	300 cm	0,80 kg	98655-947	-
[7] Kit Rain Guard F80/F65	450 cm	1,10 kg	98655-020	-
[7] Kit Rain Guard F80/F65 50	50 cm	0,10 kg	98655Z019	-
[8] Kit Rain Guard F40van VWT5/T6	270 cm	0,80 kg	98655Z039	98655Z030 - 98655Z038* 98655Z041*
[8] Kit Rain Guard F40van Ford Custom L1	2x 100 cm	0,80 kg	98655Z052	98655Z044
[8] Kit Rain Guard F40van Ford Custom L1 *	2x 100 cm	0,80 kg	98655Z047	98655Z046
[8] Kit Rain Guard F40van Ford Custom L2	2x 100 cm	0,80 kg	98655Z054	98655Z045
[8] Kit Rain Guard F40van Ford Custom L2 *	2x 100 cm	0,80 kg	98655Z053	98655Z045
[8] Kit Rain Guard F40van Mercedes V Class	2x 100 cm	0,80 kg	98655Z077	98655Z078

* for right hand drive vehicles

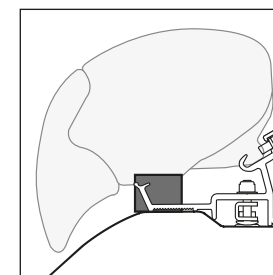

[7] Kit Rain Guard F80 /F65

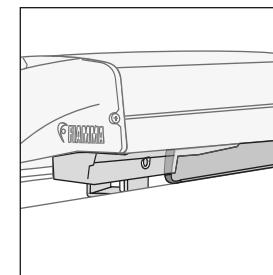

[8] Kit Rain Guard F40 Van

Awning accessories

Description	Rafter F45 / F80 / F65	Rafter Pro	Rafter CaravanStore / XL	Magicrafter	Magicrafter Pro
Item No.	98655A007	98655A002	03888-02-	98655-716	98655-847
Weight	0,8 kg		0,6 kg	0,8 kg	

Description	Kit Awning Pegs	Kit Awning Plate	Kit Awning Hangers
Item No.	98655-880	98655-724	98655-743
Weight	0,6 kg	0,3 kg	0,8 kg

Description	Tie Down Yellow	Tie Down Black	Tie Down S Yellow	Tie Down S Black	Tie Down S CaravanStore Black
Item No.	98655-128	98655-129	98655-567	98655-133	98655-638
Weight	1,2 kg				
Colour	yellow	black	yellow	black	

Description	Spoiler S	Safety Strip
Item No.	05150-01A	98655Z006
Weight	0,1 kg	
Dimensions	16x15,5h cm	-

Description	Patio-Mat 290	Patio-Mat 340	Patio-Mat 390	Patio-Mat 440	Patio-Mat 490	Patio-Bag
Item No.	07681-01-	07682-01-	07683-01-	07684-01-	07701-01-	08206-01-
Weight	3,2 kg	3,5 kg	3,8 kg	4,2 kg	4,6 kg	0,2 kg
Dimensions	2,9 x 2,5 m	3,4 x 2,5 m	3,9 x 2,5 m	4,4 x 2,5 m	4,9 x 2,5 m	90 x 35 x 16 cm
Awning length	300-310	350-360	400-410	440-450	490-500	-
Surface	7,25 m ²	8,50 m ²	9,75 m ²	11,25 m ²	12,25 m ²	-

Description	Crank Handle Short	Crank Handle Standard	Crank Handle Telescopic	Kit Repair Plus
Item No.	01756B01A	04660-01-	03878C01-	03878C01-
Weight	0,3 kg	0,4 kg	0,7 kg	0,1 kg

Motor Kit / Enclosure accessories

Description	Motor Kit Compact F80s			Motor Kit Plus F80s			Motor Kit Advanced F80s			Kit Upgrade Advanced F80s
Item No.	07929-01-	07929-01T	07929-01H	07929-02-	07929-02T	07929-02H	08320-01-	08320-01T	08320-01H	98655Z111
Colour	Polar White	Titanium	Deep Black	Polar White	Titanium	Deep Black	Polar White	Titanium	Deep Black	-
Weight	1,9 kg			2,0 kg			2,0 kg			0,1 kg

Description	Motor Kit F45s		Motor Kit F45L		Motor Kit F65s		Motor Kit F65L > 2018			Motor Kit F65L < 2018		Motor Kit F65s Integrated
Item No.	06275-01-	06275-01T	06535-01-	06535-01T	06536-01-	06536-01T	07779-01-	07779-01T	07779-01H	05725-01-	05725-01T	05823-01-
Colour	Polar White	Titanium	Polar White	Titanium	Polar White	Titanium	Polar White	Titanium	Deep Black	Polar White	Titanium	-
Weight	2,6 kg		2,6 kg		2,6 kg		2,6 kg			2,6 kg		1,1 kg

Left version of F45s and Right version of F65L (for RHD vehicles) available on request. The Motor Kit is not suitable for Fiamma ZIP awnings

Description	Kit Poles Light	CaravanStore Support Leg	Privacy Rail Kit	Moskito Net Door *	Pack Organizer Privacy	Kit Poles
Item No.	06020-01-	03732C01-	07364-01-	07365-01-	07366-01-	06537-01-
Weight	2,0 kg	1,7 kg	2,0 kg	0,7 kg	0,4 kg	0,7 kg

* Suitable for Privacy Room, Fiamma ZIP and Cstore ZIP XL, production < 2021

Description	Kit Magic Privacy Front for awnings from 260 to 360 and 450	Kit Magic Privacy Front for awnings 400/410 and 440	Kit Magic Privacy Front for awnings 500 and 550	Kit Magic Privacy Side	Door Pole F45 - CaravanStore	Door Pole F65 - F80
Item No.	06856-01-	06856-02-	06856-03-	06856-04-	05161-02-	05161-08-
Weight	2,0 kg	2,7 kg	3,0 kg	1,1 kg	0,8 kg	

Description	Mega Bag Elite	Mega Bag Smart	Rain Caps F45s	Rain Caps F45L	Curtains Kit Smoke - 2 pcs.	Curtains Kit Smoke - 6 pcs.
Item No.	08373-01-	08374-01-	06893-01-	06893A01-	98655A484	98655A483
Weight	1,2 kg	0,5 kg	0,10 kg	0,20 kg	2,7 kg	3,0 kg
Dimensions	150x35x35 cm	150x25x25 cm				

Front panels

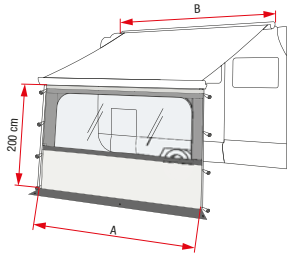

Blocker Pro

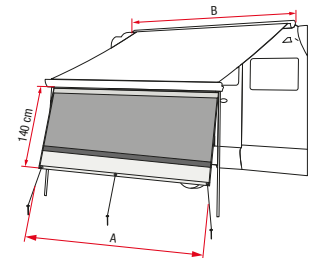

Blocker

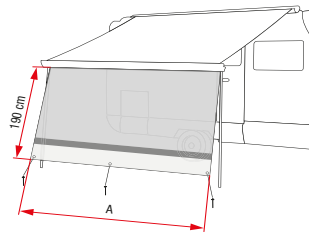

Sun View

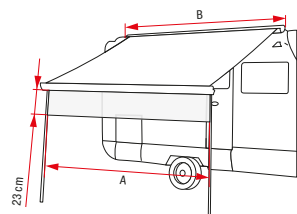

Shade Sun View

Description	F45s F45L	F80s F65s / F65L	F40 van	CStore / XL	F35 pro	Length A	Min. awning length B	Weight	Item No.
Blocker Pro 100	●	●		●	●	± 100 cm		0,8 kg	07971-12-
Blocker Pro 250	●			●	●	± 235 cm	250 cm	2,7 kg	07971-01-
Blocker Pro 260 Van*	●		●		●	± 250 cm	260 cm	2,7 kg	07971A01-
Blocker Pro 280		●		●	●	± 255 cm	270 cm	3,0 kg	07971-02-
Blocker Pro 300	●	●		●	●	± 285 cm	300 cm	3,2 kg	07971-03-
Blocker Pro 350	●	●		●		± 335 cm	340 cm	3,8 kg	07971-04-
Blocker Pro 375	●					± 360 cm	370 cm	4,1 kg	07971-05-
Blocker Pro 400	●	●		●		± 385 cm	400 cm	4,5 kg	07971-06-
Blocker Pro 425	●	●				± 410 cm	425 cm	4,7 kg	07971-07-
Blocker Pro 440				●		± 415 cm	440 cm	4,9 kg	07971-08-
Blocker Pro 450	●	●				± 435 cm	450 cm	5,0 kg	07971-09-
Blocker Pro 500	●			●		± 463 cm	500 cm	5,5 kg	07971-10-
Blocker Pro 550	●			●		± 513 cm	550 cm	6,0 kg	07971-11-
Blocker 260	●		●	●	●	± 253 cm	250 cm	2,3 kg	07972-04-
Blocker 300	●	●		●	●	± 285 cm	300 cm	2,6 kg	07972-01-
Blocker 350	●	●		●		± 335 cm	340 cm	2,9 kg	07972-02-
Blocker 400	●	●		●		± 385 cm	400 cm	3,3 kg	07972-03-
Blocker 450	●	●				± 438 cm	450 cm	4,0 kg	07972-05-
Sun View XL 100	●	●	●	●	●	± 100 cm		0,5 kg	08184-01-
Sun View XL 260	●			●	●	± 250 cm	250 cm	1,9 kg	08184-02-
Sun View XL 300	●	●		●	●	± 285 cm	300 cm	2,1 kg	08184-03-
Sun View XL 350	●	●		●		± 335 cm	340 cm	2,3 kg	08184-04-
Sun View XL 375	●					± 360 cm	370 cm	2,4 kg	08184-05-
Sun View XL 400	●	●		●		± 385 cm	400 cm	2,5 kg	08184-06-
Sun View XL 425	●	●				± 410 cm	425 cm	2,6 kg	08184-07-
Sun View XL 450	●	●				± 435 cm	450 cm	2,7 kg	08184-08-
Sun View XL 500	●			●		± 463 cm	500 cm	2,9 kg	08184-09-
Sun View XL 550	●			●		± 513 cm	550 cm	3,1 kg	08184-10-
Shade Sun View	●	●	●	●	●	± 550 cm	190 cm	0,5 kg	07758-01-

● Adatto per

* Suitable for Omnistor 5102 awning too

Side panels

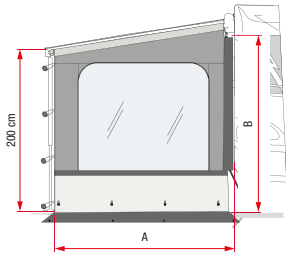

Side W Pro

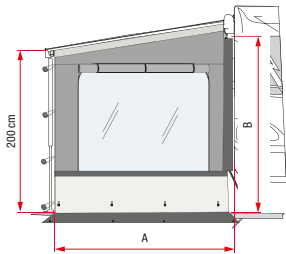

Side W Pro Shade

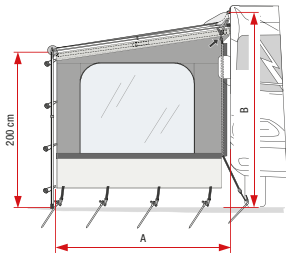

Side W CaravanStore

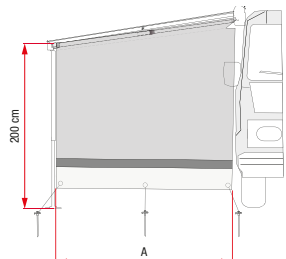

Sun View Side

Description	F45s F45L	F80s F65s / F65L	F40 van	Caravan- Store/XL	F35 pro	Length A	Height from ground B	Weight	Item No.
Side W Pro F45 / F65 / F80	●	○				230 cm	225-280 cm	4,2 kg	07973-01-
Side W Pro XXL F45 / F65 / F80	●	○				230 cm	280-330 cm	4,5 kg	07973B01-
Side W Pro Van F45*	●					190 cm	180-200 cm	3,4 kg	07973A01-
Side W Pro F65 / F80 Ducato		●				230 cm	225-280 cm	4,2 kg	07974-01-
Side W Pro F40van			●			210 cm	180-210 cm	3,0 kg	07979-01-
Side W Pro CaravanStore / F35				●	●	210 cm	240-260 cm	4,5 kg	07977-01-
Side W Pro CaravanStore XL				●		240 cm	240-260 cm	4,8 kg	07977B01-
Side W Pro F35 Van					●	210 cm	180-220 cm	4,2 kg	07977A01-
Side W Pro Shade F45 / F65 / F80 right	●	○				230 cm	225-280 cm	5,3 kg	07975-01-
Side W Pro Shade F45 / F65 / F80 left	●	○				230 cm	225-280 cm	5,3 kg	07976-01-
Side W CaravanStore / F35				●	●	210 cm	240-260 cm	3,9 kg	07978-01-
Side W CaravanStore XL				●		240 cm	240-260 cm	4,2 kg	07978A01-
Sun View Side F45 / F65 / F80	●	○				230 cm	220-260 cm	1,4 kg	08185-01-
Sun View Side CaravanStore/F35				●	●	210 cm	180-260 cm	1,3 kg	08186-01-
Sun View Side CaravanStore XL				●		240 cm	180-260 cm	1,6 kg	08186A01-
Kit Side F80s								0,1 kg	98661-017
Kit Side F65s / F65L								0,1 kg	98655-073
Kit Side Omnistor 5002/5003								0,1 kg	98655-311
Kit Side Tristor								0,1 kg	98655-079
Kit Side Omnistor 4900/5200 - Tristor 2								0,1 kg	98655-927

● Suitable for ○ Suitable by using the Kit Side

* The version Side W Pro is also suitable for Omnistor 5102 awning

Privacy Room F45

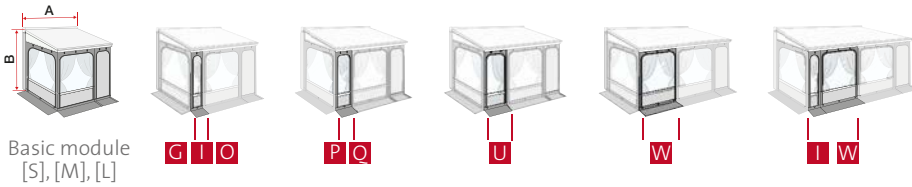

Basic module	Item No.
P. Room Van 260 Van	[S] 08366-01-
P. Room 300 - Medium	[M] 08366A01-
P. Room 300 - Large	[L] 08366B01-

Front panels	Item No.
Van 40 cm	G 08367-01-
50 cm	I 08364B01-
75 cm	O 08364D01-
100 cm	P 08364E01-
125 cm	Q 08364F01-
150 cm	U 08364H01-
200 cm	W 08364M01-

Description	Awning lenght A	Basic module B	Composition	
Privacy Room Van 260	260 cm	Van [S]	[S]	
Privacy Room Van 300	300 cm	180-220 cm	[S] + G	
P. Room 300 Medium	300 cm	Medium [M] 225-250 cm	[M]	
P. Room 350 Medium	350 cm		[M] + I	
P. Room 375 Medium	375 cm		[M] + O	
P. Room 400 Medium	400 cm		[M] + P	
P. Room 425 Medium	425 cm		[M] + Q	
P. Room 450 Medium	450 cm		[M] + U	
P. Room 300 Large	300 cm		Large [L] 251-280 cm	[L]
P. Room 350 Large	350 cm			[L] + I
P. Room 375 Large	375 cm	[L] + O		
P. Room 400 Large	400 cm	[L] + P		
P. Room 425 Large	425 cm	[L] + Q		
P. Room 450 Large	450 cm	[L] + U		
P. Room 500 Large	500 cm	[L] + W		
P. Room 550 Large	550 cm	[L] + N + W		

Privacy Room F65 / F80

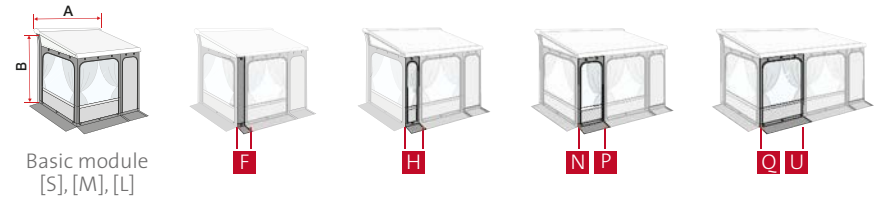

Basic module	Item No.
P. Room 300 Ducato >06	[S] 08368-01-
P. Room 300 H3 *	[M] 08368A01-
P. Room 300 / H: 245-280 **	[L] 08368B01-

Front panels	Item No.
20 cm	F 08364-01-
40 cm	H 08364A01-
70 cm	N 08364C01-
100 cm	P 08364E01-
125 cm	Q 08364F01-
150 cm	U 08364H01-

* Designed for Mercedes Sprinter, VW Crafter, Fiat Ducato, Citroën Jumper and Peugeot Boxer - H3, Fast Clip Light aluminium poles delivered as standard.
 ** This model is suitable for vehicles with straight wall, height from ground 245-280cm.

Description	Awning lenght A	Basic module B	Composition
P. Room 300 Ducato >06/06	300 cm	Van [S] 245 cm	[S]
P. Room 320 Ducato >06/06	320 cm		[S] + F
P. Room 340 Ducato >06/06	340 cm		[S] + H
P. Room 370 Ducato >06/06	370 cm		[S] + N
P. Room 400 Ducato >06/06	400 cm		[S] + P
P. Room 425 Ducato >06/06	425 cm		[S] + Q
P. Room 450 Ducato >06/06	450 cm		[S] + U
P. Room 300 H3	300 cm		Medium [M] 245-280 cm
P. Room 320 H3	320 cm	[M] + F	
P. Room 340 H3	340 cm	[M] + H	
P. Room 370 H3	370 cm	[M] + N	
P. Room 400 H3	400 cm	[M] + P	
P. Room 425 H3	425 cm	[M] + Q	
P. Room 450 H3	450 cm	[M] + U	
P. Room 300 / H: 245-280	300 cm	Large [L] 280 cm	[L]
P. Room 320 / H: 245-280	320 cm		[L] + F
P. Room 340 / H: 245-280	340 cm		[L] + H
P. Room 370 / H: 245-280	370 cm		[L] + N
P. Room 400 / H: 245-280	400 cm		[L] + P
P. Room 425 / H: 245-280	425 cm		[L] + Q
P. Room 450 / H: 245-280	450 cm		[L] + U

Privacy Room Light

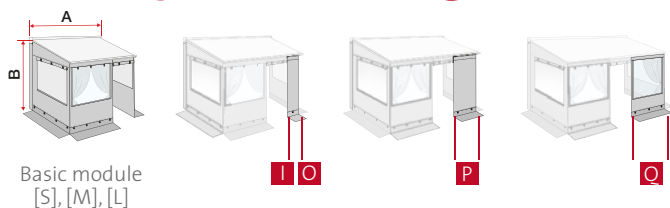

Basic module	Item No.
P. Room Van 260	[S] 08362-01-
P. Room 300 - Medium	[M] 08362A01-
P. Room 300 - Large	[L] 08362B01-

Front panels	Item No.
50 cm	I 08361A01-
75 cm	O 08361B01-
100 cm	P 08361C01-
125 cm	Q 08361D01-

Description	Awning length A	Basic module B	Composition
Privacy Room Van 260	260 cm	Van [S] 180-220 cm	[S]
P. Room 300 Medium	300 cm	Medium [M] 225-250 cm	[M]
P. Room 350 Medium	350 cm		[M] + I
P. Room 375 Medium	375 cm		[M] + O
P. Room 400 Medium	400 cm		[M] + P
P. Room 425 Medium	425 cm		[M] + Q
P. Room 300 Large	300 cm	Large [L] 251-280 cm	[L]
P. Room 350 Large	350 cm		[L] + I
P. Room 375 Large	375 cm		[L] + O
P. Room 400 Large	400 cm		[L] + P
P. Room 425 Large	425 cm		[L] + Q

Privacy Room CS Light / XL

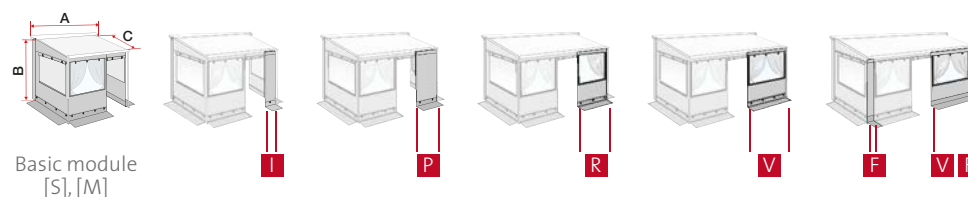

Basic module	Item No.
P. R. CS Light 280	08360-01-
P. R. CS Light 310	[S] 08360-02-
P. R. CS Light 250 Van	08360A01-
P. R. CS Light 270 Van	08360A02-
P. R. CS Light XL 280	08360B01-
P. R. CS Light XL 310	[S] 08360B02-

Front panels	Item No.
20 cm	F 08361-01-
50 cm	I 08361A01-
100 cm	P 08361C01-
130 cm	R 08361E01-
190 cm	V 08361F01-

Description	Awning length A	B	C	Composition
P. R. CS Light 250 Van	250 cm	180-220 cm	225 cm	-
P. R. CS Light 270 Van	270 cm			-
P. R. CS Light XL 280	280 cm			-
P. Room CS Light 310	310 cm	240-260 cm	[S] 225 cm	[S]
P. Room CS Light 360	360 cm			[S] + I
P. Room CS Light 410	410 cm			[S] + P
P. Room CS Light 440	440 cm		[S] + R	
P. Room CS Light 310	310 cm		[M] 250 cm	[M]
P. Room CS Light 360	360 cm			[M] + I
P. Room CS Light 410	410 cm			[M] + P
P. Room CS Light 440	440 cm			[M] + R
P. Room CS Light 500	500 cm			[M] + V
P. Room CS Light 550	550 cm			[M] + F + V + F

Privacy Ultra Light

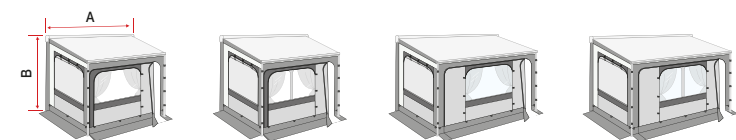

P.R. Ultra Light Van 260
P.R. Ultra Light 300

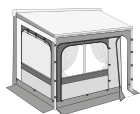

P.R. Ultra Light 300

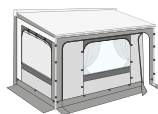

P.R. Ultra Light 400

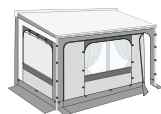

P.R. Ultra Light 450

Description	Awning length A	B	Weight	Item No.
Privacy Ultra Light Van 260	260 cm	180-220 cm	12,3 kg	07350A01-
Privacy Ultra Light 300	300 / 320 cm	230-280 cm	14,2 kg	07350-01-
Privacy Ultra Light 350	350 / 370 cm		15,4 kg	07350-02-
Privacy Ultra Light 400	400 cm		16,6 kg	07350-03-
Privacy Ultra Light 450	450 cm		17,8 kg	07350-04-

Room Van

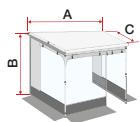

Room Van Premium

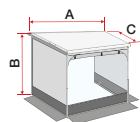

Room Van

Description	Awning length A	B	C	Weight	Item No.
Room Van Premium	270 cm	180-210 cm	225 cm	5,4 kg	08210-01-
Room Van				4,8 kg	08209-01-

Fiamma ZIP

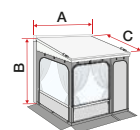

Basic module
[M], [L]



I



P



U

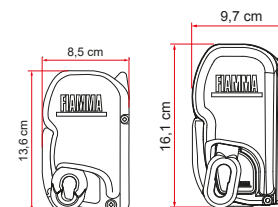

Fiamma ZIP S

Fiamma ZIP L

Privacy ZIP - Basic module	Item No.
Fiamma ZIP 300 M	[M] 08365-01-
Fiamma ZIP 300 L	[L] 08365A01-

Front panels	Item No.
50 cm	I 08364B01-
100 cm	P 08364E01-
150 cm	U 08364H01-

Description	ZIP awning
F45s ZIP 300	[D] 06463A01(X)
F45s ZIP 350	[E] 06463B01(X)
F45L ZIP 400	[F] 06531-01(X)
F45L ZIP 450	[G] 06531A01(X)

Specify the fabric colour you want when ordering by replacing (X) with:
R=Royal Grey, Q=Royal Blue

Description	B	C	ZIP awning	Privacy ZIP
Fiamma ZIP S 300 Medium	[M]	250 cm	[D] +	[M]
Fiamma ZIP S 350 Medium	Medium		[E] +	[M] + I
Fiamma ZIP L 400 Medium	225-250 cm		[F] +	[M] + P
Fiamma ZIP L 450 Medium			[G] +	[M] + U
Fiamma ZIP S 300 Large	[L]	251-280 cm	[D] +	[L]
Fiamma ZIP S 350 Large	Large		[E] +	[L] + I
Fiamma ZIP L 400 Large	251-280 cm		[F] +	[L] + P
Fiamma ZIP L 450 Large			[G] +	[L] + U

CaravanStore ZIP XL

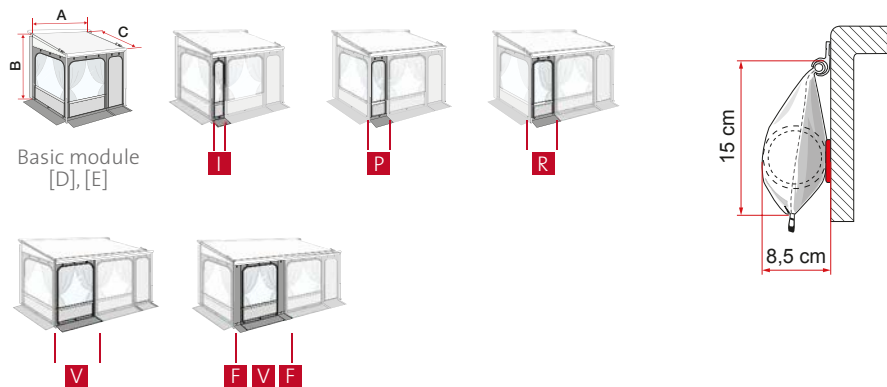

Privacy Cstore ZIP - Basic module	Item No.
CaravanStore ZIP XL 280	[D] 08363-01-
CaravanStore ZIP XL 310	[E] 08363-02-

Description	ZIP awning
CaravanStore ZIP XL 280	[G] 06771Co2(X)
CaravanStore ZIP XL 310	[H] 06771Do2(X)
CaravanStore ZIP XL 360	[L] 06771Eo2(X)
CaravanStore ZIP XL 410	[M] 06771Fo2(X)
CaravanStore ZIP XL 440	[N] 06771Go2(X)
CaravanStore ZIP XL 500	[Q] 06771Ho2(X)
CaravanStore ZIP XL 550	[S] 06771Lo2(X)

Privacy CStore ZIP - front panels	Item No.
20 cm	F 08364-01-
50 cm	O 08364Bo1-
100 cm	P 08364Eo1-
130 cm	R 08364Go1-
190 cm	V 08364Lo1-

Specify the fabric colour you want when ordering by replacing (X) with: R=Royal Grey, Q=Royal Blue

Description	B	C	ZIP awning	Privacy ZIP
CaravanStore ZIP XL 280	260-240 cm	250 cm	[G]	[D]
CaravanStore ZIP XL 310			[H]	[E]
CaravanStore ZIP XL 360			[L]	[E] + I
CaravanStore ZIP XL 410			[M]	[E] + P
CaravanStore ZIP XL 440			[N]	[E] + R
CaravanStore ZIP XL 500			[Q]	[E] + V
CaravanStore ZIP XL 550			[S]	[E] + F (x2) + V

Rear Door Cover

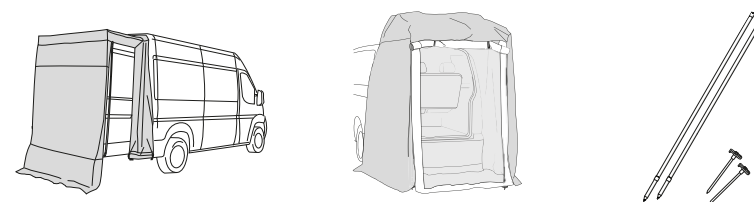

	Rear Door Cover Ducato	Rear Door Cover VW T5/T6	Kit Poles
Item No.	06357-01-	06539-01-	06537-01-
Weight	3,3 kg	9,8 kg	0,7 kg

Skirting

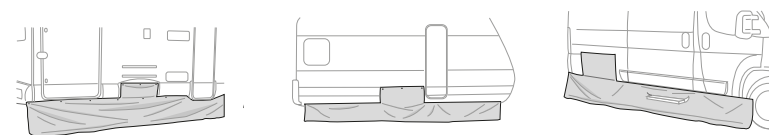

	Skirting Motorhome	Skirting Caravan	Skirting VW T5/T6
Item No.	98655-090	98655-084	98655-387
Weight	1,7 kg	1,8 kg	0,7 kg

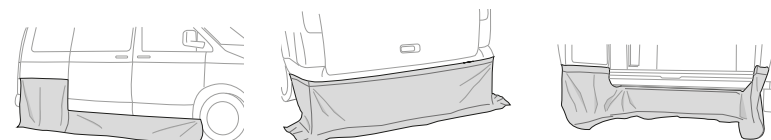

	Skirting Ducato	Rear Skirting Ducato	Rear Skirting VW T5/T6
Item No.	98655-405	06469-01-	06538-01-
Weight	1,4 kg	1,7 kg	1,1 kg

Carry - Bike

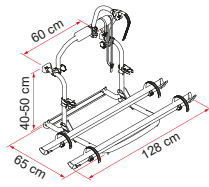
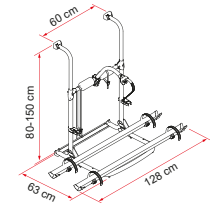
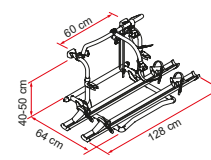
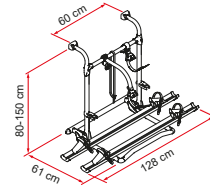
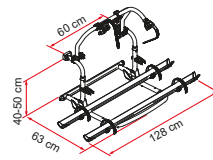
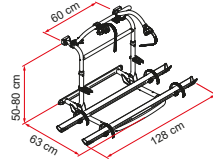
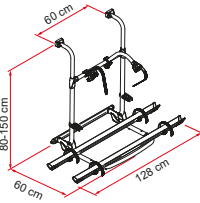

Description	Pro / Pro N	Pro M / Pro M N	Pro C / Pro C N
Item No.	02094-09A / 02094-09V**	02094-11A / 02094-11V**	02094-10A / 02094-10V**
Colour	Aluminium	Aluminium	Aluminium
Installation			
Vehicle	Motorhome	Motorhome	Motorhome
Technical features			
Bikes carried standard	2	2	2
Bikes carried max	4	4	4
Max load	60 kg	60 kg	60 kg
E-Bike			
Position	Rear wall	Rear wall	Rear wall
Vertical wheelbase	80 - 150 cm	50 - 80 cm	40 - 50 cm
Horizontal wheelbase (distance between brackets)	60 cm	60 cm	60 cm
Dimensions*	128 x 60 x 80 cm	128 x 63 x 50 cm	128 x 63 x 40 cm
Weight	8,4 kg	8,5 kg	7,9 kg
Easy Position	●	●	●
Rail type	Rail Quick Pro	Rail Quick Pro	Rail Quick Pro
Distance between rails	15 cm	15 cm	15 cm
A-frame: minimum size			
Licence Plate Carrier	-	-	-

Pro E-Bike	Pro C E-Bike
02094B12A	02094B13A
Aluminium	Aluminium
Motorhome	Motorhome
2	2
2	2
60 kg	60 kg
●	●
Rear wall	Rear wall
80 - 150 cm	40 - 50 cm
61 cm	64 cm
128 x 61 x 80 cm	128 x 64 x 40 cm
10,4 kg	9,9 kg
●	●
Rail Premium	Rail Premium
23 cm	23 cm
-	-

UL	CL
02093B86A	02093B87A
Aluminium	Aluminium
Motorhome	Motorhome
2	2
3	3
50 kg	50 kg
Rear wall	Rear wall
80 - 150 cm	40 - 150 cm
60 cm	60 cm
128 x 63 x 80 cm	128 x 65 x 40 cm
5,6 kg	5,6 kg
Rail Quick Pro	Rail Quick Pro
15 cm	15 cm
-	-

● Standard ○ Optional

* with rail support base in standard open position and in models with minimum adjustable vertical wheelbase
 ** N version (Item No. 02094-09V, 02094-11V and 02094-10V) for vehicles with Fiamma original brackets pre-installed on it.

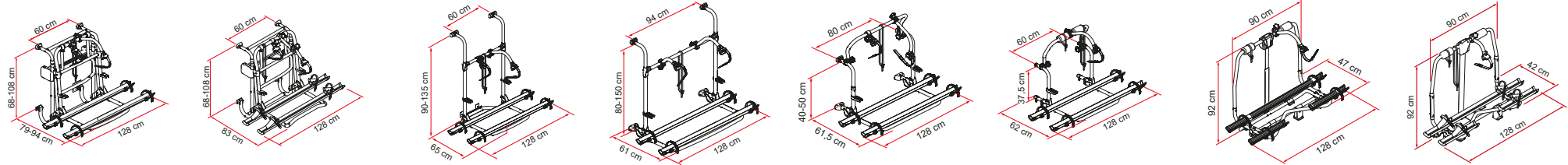

Lift 77	Lift 77 E -Bike
02093F43A	02093E43A
Aluminium	Aluminium
Motorhome	Motorhome
2	2
4	2
60 kg	50 kg
	●
Rear wall	Rear wall
68 -108 cm	68 - 108 cm
60 cm	60 cm
128 x 79 x 68 cm	128 x 83 x 68 cm
18,3 kg	18,3 kg
●	●
Rail Quick Pro	Rail Premium
15 cm	23 cm
-	-

Pro Hymer - Dethleffs	Pro Autotrail	Pro C L80	Trigano - CI Roller Team
02093A64B	02093A98A	02093B59A	02093A57A
Aluminium	Aluminium	Aluminium	Aluminium
Motorhome	Motorhome	Motorhome	Motorhome
2	2	2	2
2	2	4	3
60 kg	40 kg	60 kg	50 kg
Rear wall	Rear wall	Rear wall	Rear wall
90 - 135 cm	80 -150 cm	40 - 50 cm	38,5 cm
60 cm	94 cm	80 cm	60 cm
128 x 64 x 90 cm	128 x 61 x 80 cm	128 x 62 x 40 cm	128 x 62 x 37,5 cm
8,2 kg	12 kg	7,9 kg	5,2 kg
●	●	●	●
Rail Quick Pro	Rail Quick Pro	Rail Quick Pro	Rail Quick Pro
15 cm	15 cm	15 cm	15 cm
-	-	-	-

Caravan Active	Caravan Active E-Bike
02094-05A	02094A06A
Aluminium	Aluminium
Caravan	Caravan
2	2
2	2
50 kg	60 kg
	●
A frame	A frame
128 x 47 x 92 cm	128 x 42 x 92 cm
7,5 kg	10,0 kg
●	●
Rail Quick Pro	Rail Premium
15 cm	20 cm
315 cm	280 cm
-	-

Carry - Bike

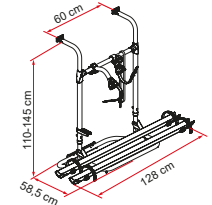
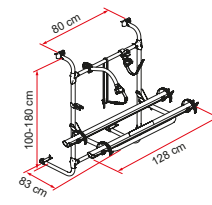
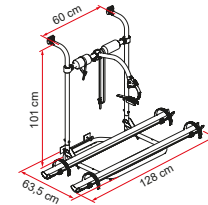
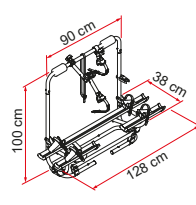
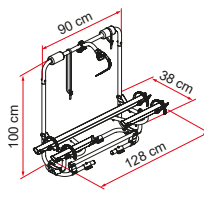
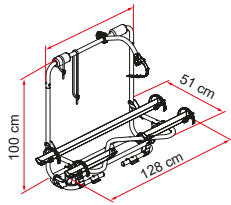
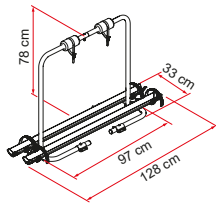

Description	Caravan XL A	Caravan XL A Pro	Caravan XL A Pro 200	Caravan XL A Pro 200 E-Bike	Caravan Hobby	Caravan Universal	Simple Plus 200
Item No.	02094-23A	02093B91A / 02093C91A	02093F32A / 02093G32A	02093E32A	02093A77A	02093A76A	02093A36A
Colour	Aluminium	Aluminium / Deep Black	Aluminium / Deep Black	Aluminium	Aluminium	Aluminium	Aluminium
Installation							
Vehicle	Caravan	Caravan	Caravan	Caravan	Caravan	Caravan	Caravan
Technical features							
Bikes carried standard	2	2	2	2	2	2	2
Bikes carried max	2	3	2	2	3	2	2
Max load	35 kg	50 kg	50 kg	50 kg	50 kg	35 kg	35 kg
E-Bike				●			
Position	A frame	A frame	A frame	A frame	Rear wall	Rear wall	Rear wall
Vertical wheelbase					101 cm	100 - 180 cm	110 - 145 cm
Horizontal wheelbase (distance between brackets)					60 cm	80 cm	60 cm
Dimensions *	128 x 33 x 78 cm	128 x 51 x 100 cm	128 x 38 x 100 cm	128 x 38 x 100 cm	128 x 63,5 x 101 cm	128 x 86 x 100 cm	128 x 58,5 x 110 cm
Weight	5,3 kg	9,0 kg	7,5 kg	10,0 kg	5,6 kg	7,5 kg	6,4 kg
Easy Position					●	●	●
Rail	Rail Quick Pro	Rail Quick Pro	Rail Quick Pro	Rail Premium	Rail Quick Pro	Rail Quick Pro	Rail Quick Pro
Distance between rails	15 cm	15 cm	20 cm	20 cm	15 cm	30 cm	15 cm
A-frame: minimum size	402 cm	342 cm	342 cm	342 cm			
Licence Plate Carrier	-	-	-	-	-	-	-

● Standard ● Optional

*with rail support base in standard open position and in models with minimum adjustable vertical wheelbase

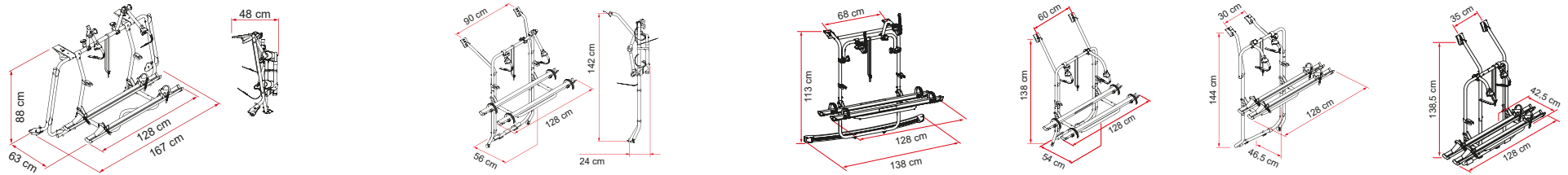

VW T5 Pro	VW T6 Pro	VW T5	VW T6
02093E71A	02094B08A / 02094A08A	02094-17A	02094-20A
Aluminium	Aluminium / Deep Black	Aluminium	Aluminium
Campervan	Campervan	Campervan	Campervan
2	2	2	2
4	4	4	4
60 kg	60 kg	60 kg	60 kg
tailgate	tailgate	tailgate	tailgate
88 cm	88 cm	142 cm	142 cm
167 cm	167 cm	90 cm	90 cm
167 x 63 x 88 cm	167 x 63 x 88 cm	128 x 56 x 142 cm	128 x 56 x 142 cm
14 kg	14 kg	8,3 kg	8,3 kg
●	●	●	●
Rail Premium	Rail Premium	Rail Quick Pro	Rail Quick Pro
15 cm	15 cm	15 cm	15 cm
○	○	○	○

VW Caddy	VW T4	VW T5 / T6 D	VW T4 D
02094-24A	02094-18A	02093B79A	02094-22A
Aluminium	Aluminium	Aluminium	Aluminium
Campervan	Campervan	Campervan	Campervan
2	2	2	2
4	4	2	2
60 kg	60 kg	35 kg	35 kg
tailgate	tailgate	double door	double door
130 cm	138 cm	144 cm	138,5 cm
68 cm	60 cm	30 cm	35 cm
128 x 55 x 130 cm	128 x 54 x 138 cm	128 x 46,5 x 144 cm	128 x 42,5 x 138,5 cm
10,0 kg	8,3 kg	7,7 kg	7,7 kg
●	●	●	●
Rail Quick Pro	Rail Quick Pro	Rail Premium	Rail Premium
15 cm	15 cm	15 cm	15 cm
○	○	○	○

Carry - Bike

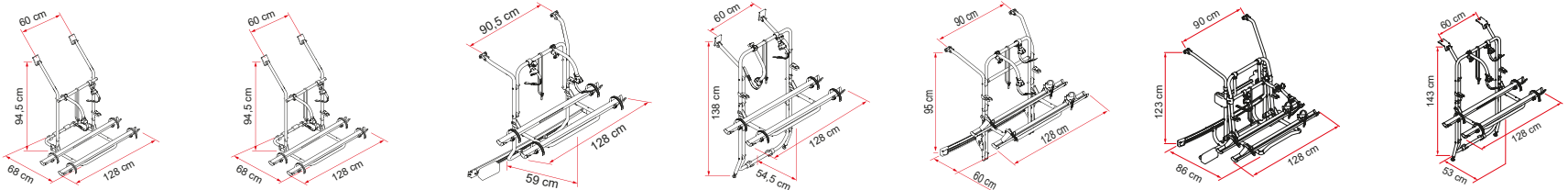

Description	VW T3 (T25)	VW T2	Mercedes Viano	Mercedes Vito	Mercedes V Class Premium	Mercedes V Class Premium Lift E-Bike	Opel Vivaro - Renault Trafic
Item No.	02094-19A	02093B63A	02093B75A	02093A05A	02094B14A	02094A15A	02093B72A
Colour	Aluminium	Aluminium	Aluminium	Aluminium	Aluminium	Aluminium	Aluminium
Installation							
Vehicle	Campervan	Campervan	Campervan	Campervan	Campervan	Campervan	Campervan
Technical features							
Bikes carried standard	2	2	2	2	2	2	2
Bikes carried max	3	2	3	4	4	2	4
Max load	50 kg	35 kg	50 kg	60 kg	60 kg	60 kg	60 kg
E-Bike						●	
Position	tailgate	tailgate	tailgate	tailgate	tailgate	tailgate	tailgate
Vertical wheelbase	94,5 cm	76 cm	110,5 cm	138 cm	95 cm	123 cm	143 cm
Horizontal wheelbase (distance between brackets)	60 cm	60 cm	90,5 cm	60 cm	90 cm	90 cm	60 cm
Dimensions *	128 x 68 x 94,5 cm	128 x 63 x 76 cm	128 x 59 x 110,5 cm	128 x 54,5 x 138 cm	128 x 60/70 x 95 cm	128 x 86 x 123 cm	128 x 53 x 143 cm
Weight	6,5 kg	7,0 kg	10,0 kg	8,7 kg	12,5 kg	20,5 kg	8,7 kg
Easy Position	●	●	●	●	●		●
Rail type	Rail Quick Pro	Rail Quick Pro	Rail Quick Pro	Rail Quick Pro	Rail Premium	Rail Premium	Rail Quick Pro
Distance between rails	15 cm	15 cm	15 cm	15 cm	15 cm	23 cm	15 cm
A-frame: minimum size							
Licence Plate Carrier	○		●	○	○	●	○

● Standard ○ Optional

* with rail support base in standard open position and in models with minimum adjustable vertical wheelbase

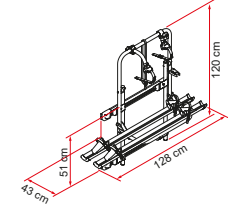
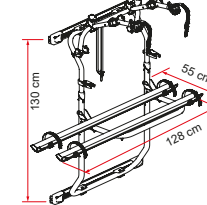
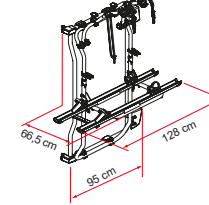
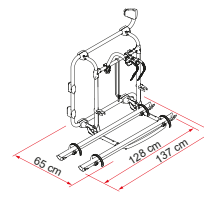
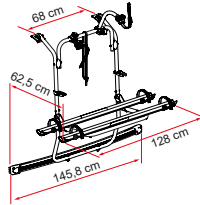
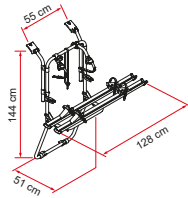
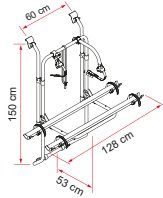
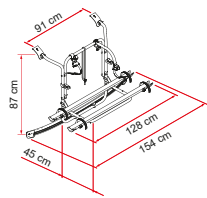

Ford Custom	Ford Transit	Renault Trafic D	PSA
02094B07A	02093A60A	02093B74A	02094-28A / 02094A28A
Aluminium	Aluminium	Aluminium	Aluminium
Campervan	Campervan	Campervan	Campervan
2	2	2	2
3	3	2	4
50 kg	50 kg	35 kg	60 kg
tailgate	tailgate	rear double door	tailgate
128 cm	150 cm	144 cm	114 cm
91 cm	60 cm	55 cm	68 cm
154 x 45 x 87 cm	128 x 53 x 150 cm	128 x 51 x 144 cm	145,8 x 62,5 x 120 cm
8,5 kg	7,1 kg	8,2 kg	14,0 kg
●	●	●	●
Rail Quick Pro	Rail Quick Pro	Rail Quick Pro	Rail Quick Pro
15 cm	15 cm	15 cm	15 cm
○	○	○	○

Frame Crafter E-Bike	Frame Ducato E-Bike	200 DJ Ducato > 2006	200 DJ Ducato < 2006
02094-31A	02094-27A / 02094A27A	02094-26A / 02094A26A	02093A65A
Aluminium	Aluminium / Deep Black	Aluminium / Deep Black	Aluminium
Van conversion	Van conversion	Van conversion	Van conversion
2	2	2	2
2	2	2	2
50 kg	50 kg	35 kg	35 kg
●	●	rear double door	
116 cm	139 cm	130 cm	120 cm
137 x 65 x 116 cm	128 x 67 x 139 cm	128 x 55 x 130 cm	128 x 43 x 120 cm
16,0 kg	21,0 kg	11,0 kg	9,0 kg
Rail Premium	Rail Premium	Rail Quick Pro	Rail Premium
15 cm	23 cm	23 cm	15 cm
○	○	○	○

Carry - Bike

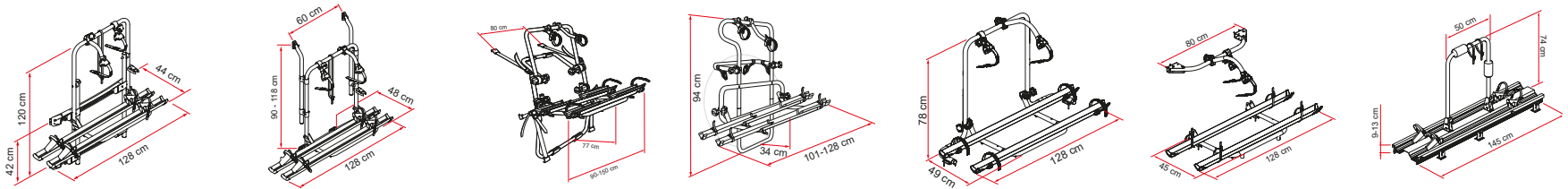

Description	200 DJ Sprinter / Crafter	200 D	Backpack	Backpack 4x4	Garage Plus	Garage Standard	Garage Slide Pro Bike
Item No.	02093B93A / 02093A93A	02093A15A	02093A38-	02093B38-	02093A78A	02093A54A	04822-05-
Colour	Aluminium/ Deep Black	Aluminium	Aluminium	Aluminium	Aluminium	Aluminium	Aluminium
Installation							
Vehicle	Van conversion	Van conversion	4 x 4	4 x 4	Garage	Garage	Garage
Technical features							
Bikes carried standard	2	2	2	2	2	2	2
Bikes carried max	2	2	2	2	4	3	2
Max load	35 kg	35 kg	50 kg	35 kg	60 kg	50 kg	50 kg
E-Bike							
Position	rear double door		tailgate	tailgate	garage facility		
Vertical wheelbase	120 cm	90 - 118 cxm		94 cm			
Horizontal wheelbase (distance between brackets)		60 cm	80 cm			80 cm	
Dimensions *	128 x 44 x 120 cm	128 x 48 x 90 cm	90 x 77 cm	101 x 34 x 94 cm	128 x 49,5 x 78 cm	128 x 45	145 x 34 x 74 cm (closed)
Weight	9,0 kg	6,9 kg	8,0 kg	7,8 kg	5,6 kg	4,8 kg	9,9 kg
Easy Position			●	●	●	●	
Rail type	Rail Premium	Rail Premium	Rail Quick C	Rail Strip C	Rail Quick Pro	Rail Quick Pro	
Distance between rails	15 cm	15 cm	15 cm	15 cm			
A-frame: minimum size							
Licence Plate Carrier	●	●	-	-	-	-	-

● Standard ○ Optional

* with rail support base in standard open position and in models with minimum adjustable vertical wheelbase

Carry - Bike

Carry-Bike Moto

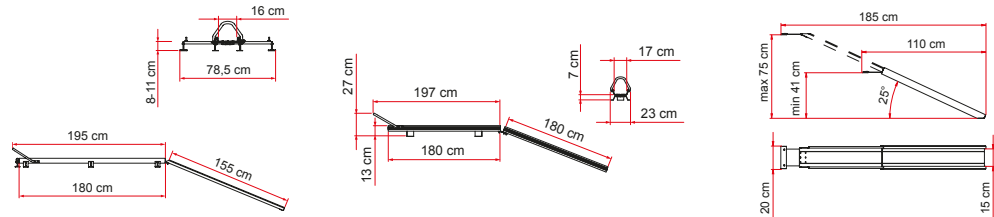

Garage Pack Plus	Garage Pack
98655A911	98655A910
Aluminium	Aluminium
Garage	Garage
2	2
3	3
garage facility	
10,5 kg	4,0 kg
Rail Strip Pro	Rail Strip Pro

Description	Carry-Moto	Carry-Moto Pro	Carry-Ramp
Item No.	02095-01-	02095-03-	02095-04-
Vehicle	Motorhome • Van conversion	Motorhome • Van conversion	Motorhome • Van conversion
Weight	12,2 kg	15,4 kg	7 kg
Max load	200 kg	200 kg	130 kg
Telescopic		●	●
Ramp angle	variable	variable	fixed 25°
Wheel chock front	●	●	○
Wheel chock rear			○
Fastening straps	●	●	
Wheel width max	14 cm	16 cm	15 cm

● Standard ○ Optional

Description	[1] Moto Wheel Chock Front	[2] Moto Wheel Chock Rear
Item No.	05781-01-	05800-01-
Vehicle	Motorhome / Van conversion	Motorhome / Van conversion
Weight	2,4 kg	2,8 kg
Wheel width max.	18 cm	18 cm

[1] Moto Wheel Chock Front

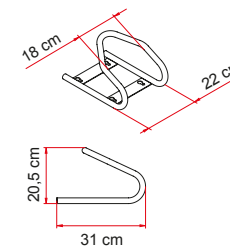

[2] Moto Wheel Chock Rear

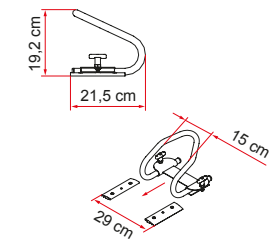

Bike Block Pro S

[1] Bike-Block Pro S 1



[2] Bike-Block Pro S 2

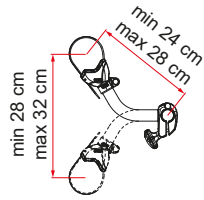

[3] Bike-Block Pro S 3

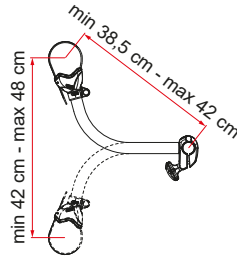

[4] Bike-Block Pro S 4

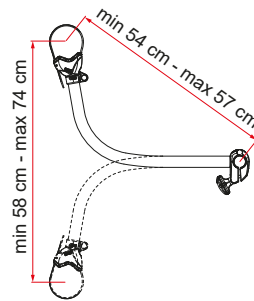

[5] Bike-Block Pro S D1

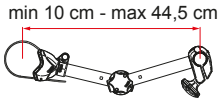

[6] Bike-Block Pro S D2

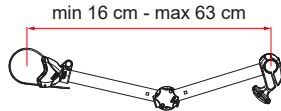

[7] Bike-Block Pro S D3

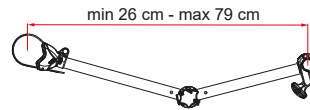

Description	Item No.	Colour	Weight
[1] Bike-Block Pro S 1	07215-01A	black	0,2 kg
[2] Bike-Block Pro S 2	07215A01A	black	0,3 kg
[3] Bike-Block Pro S 3	07215B01A	black	0,4 kg
[4] Bike-Block Pro S 4	07215C01A	black	0,5 kg
[5] Bike-Block Pro S D1	07215D01A	black	0,6 kg
	07215G01A	Deep Black	
[6] Bike-Block Pro S D2	07215E01A	black	0,7 kg
	07215H01A	Deep Black	
[7] Bike-Block Pro S D3	07215F01A	black	0,8 kg
	07215I01A	Deep Black	

Bike Block Pro

[1] Bike-Block Pro 1

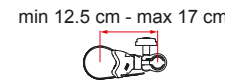

[2] Bike-Block Pro 2

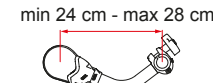

[3] Bike-Block Pro 3

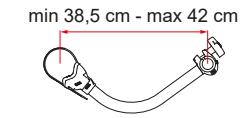

[4] Bike-Block Pro 4

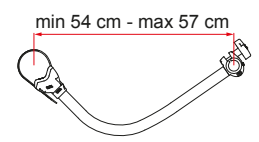

[5] Bike-Block Pro D1

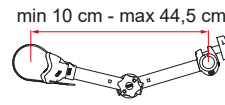

[6] Bike-Block Pro D2

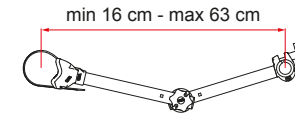

[7] Bike-Block Pro D3

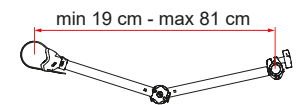

[8] Bike Frame Adapter

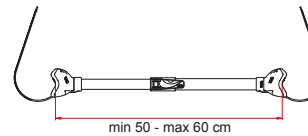

Description	Item No.	Colour	Weight
[1] Bike-Block Pro 1*	04133-01A	black	0,2 kg
[2] Bike-Block Pro 2*	04133A01A	black	0,3 kg
[3] Bike-Block Pro 3*	04133B01A	black	0,4 kg
[4] Bike-Block Pro 4*	04133C01A	black	0,5 kg
[5] Bike-Block Pro D1**	04133E01A	black	0,6 kg
[6] Bike-Block Pro D2**	04133F01A	black	0,7 kg
[7] Bike-Block Pro D3	04133G01A	black	0,8 kg
[8] Bike Frame Adapter	06602-01-		0,5 kg

* Available on request the red, blue and grey versions

** Available on request the red version

Rail

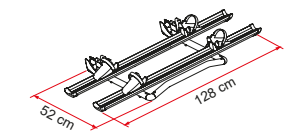
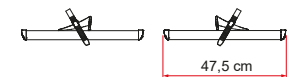
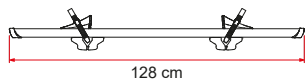
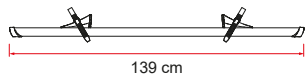
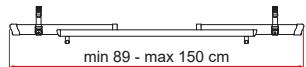
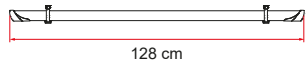
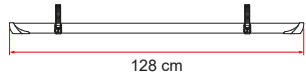

Description	Item No.	Colour	Hooking type	Left-Right sliding	Back-Forward sliding	Length	Weight
Rail Quick Pro	98656-993	black	Quick Safe	●	○	128 cm	1,0 kg
	98656M040	blue					
	98656M289	grey					
	98656M358	Deep Black					
Rail Strip Pro	98656M288	black	Strip	●	○	128 cm	1,0 kg
Rail Quick C	98656-369	black	Quick Safe	●	○	101-167 cm	1,2 kg

Rail Premium	98656M131	black	Premium Quick	●	○	128 cm	1,3 kg
	98656M150	Deep Black					
Rail Premium XL	98656M132	black	Premium Quick	●	○	139 cm	1,9 kg
	98656M153	Deep Black	Premium Quick				
Rail Premium S	98656M133	black	Premium Quick	●	●	128 cm	1,7 kg
	98656M152	Deep Black					
Rail Premium S Fat Bike	98656M146	black	Premium Quick	●	○	128 cm	2,0 kg
	98656M151	Deep Black					
Kit Rail Premium 48	98656M087	black	Premium Quick	●	○	101-167 cm 101-167 cm	1,2 kg
	98656M147	Deep Black					1,2 kg
Kit Upgrade E-Bike	98656M137	black	Premium Quick	●	○	128 cm	5,5 kg
Kit Premium S	98656M134	black					0,3 kg

● Standard ○ Optional (by using Kit Premium S)

Kit Upgrade

Description	Kit Upgrade VW T6	Kit Upgrade VW T6 Pro	Kit Upgrade 3 bikes Frame Crafter	Kit Upgrade 3 bikes Frame Ducato
Item No.	98656-988	98656M021	98656M560	98656M561
Weight	0,7 kg	0,7 kg	7,0 kg	7,0 kg

Locking System

Description	Quick-Safe	Strip Red	Strip Black	Security Strip	Cable-Lock
Item No.	98656-386	98656-320	98656-318	98656-419	98656-338
Weight	0,1 kg	0,1 kg	0,1 kg	0,1 kg	0,1 kg

Installation Kit

[1] Licence Plate Carrier

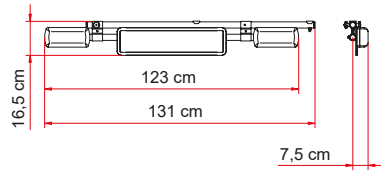

[2] Kit Support Bar

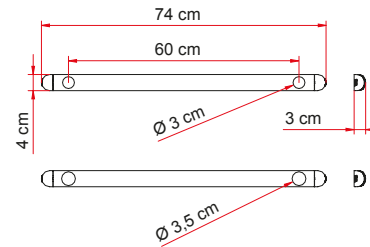

[3] Fixing-Bar Carry-Bike

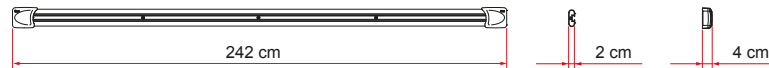

Dust Guard

Description	Dust Guard
Item No.	07752-01-
Colour	Black
Weight	0,3 kg
Length	240 cm

Suitable for	
Fixing Bar Carry-Bike	
Carry-Bike 200 DJ Ducato > 2006	
Carry-Bike 200 DJ Ducato < 2006	
Carry-Bike 200 DJ Sprinter	
Carry-Bike Mercedes Viano	
Carry-Bike Ford Custom	
Carry-Bike PSA	
Carry-Bike M. V Class Premium	
Carry-Bike M. V Class Lift E-Bike	
Deluxe DJ Ducato	
Deluxe DJ Ducato H3	
Deluxe DJ Sprinter	

Description	[1] Licence Plate Carrier	[2] Kit Support Bar	[3] Fixing-Bar Carry-Bike
Item No.	06146B01- / 06146B01A	98656-682	98656-474
Colour	Aluminium/ Deep Black	Aluminium	Aluminium
Weight	2,4 kg	1,2 kg	5,5 kg
Length	131 cm	74 cm	240 cm

Kit Dethleffs < 2010	Kit Dethleffs > 2010	Kit Dethleffs > 2016
98656-640	98656-725	98656M296
Aluminium	Aluminium	Aluminium
0,4 kg	0,5 kg	0,5 kg
13 cm	12,5 cm	12,5 cm

Ultra-Box

[1] Ultra-Box 320

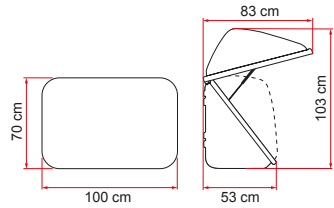

[2] Ultra-Box 360

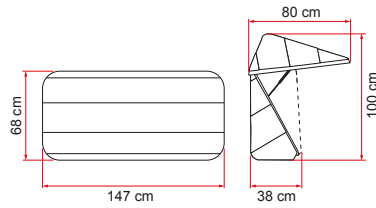

[3] Ultra-Box 500

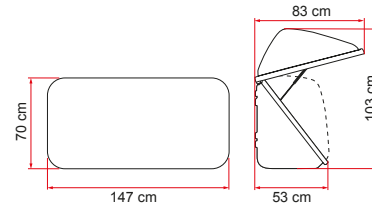

Description	[1] Ultra-Box 320 *	[2] Ultra-Box 360 *	[3] Ultra-Box 500 *
Item No.	04147-01-	02801-01-	04148-01-
Volume	320 l	360 l	500 l
External dimensions	100x53x70 cm	147x38x68 cm	147x53x70 cm
Internal dimensions	88,5x46x62 cm	133,5x30x58 cm	133,5x46x62 cm
Weight	12,0 kg	14,0 kg	17,0 kg

Bike Cover

Description	Bike Cover S (2/3 bikes) *	Bike Cover S (4 bikes) *	Bike Cover Premium S *	Bike Cover Caravan
Item No.	08208-01-	08208A01-	08208B01-	08208C01-
Biciclette covered	2/3	4	4	2
Vehicle type	Motorhome	Motorhome	Motorhome	Caravan
Closing system	Elastic band with hooks	Elastic band with hooks	Zippers	Elastic band with lock
Weight	0,9 kg	1,0 kg	0,9 kg	0,8 kg

* Not suitable for bike racks where the bikes are exposed over the top of the roof

Cargo Back / Easy Dry

Easy Dry

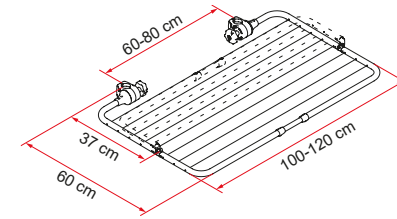

Description	Cargo Back *	Kit Frame Cargo Back	Easy Dry
Item No.	08205-01-	06106-01-	06306-01-
Volume	285 l		
Dimensions	120x70x35 cm	119x69x32 cm	100x60 cm
Weight	1,4 kg	1,2 kg	1,2 kg

* Not suitable for Carry-Bike with offset rails

Signal

Description	Alu Signal	Plastic Signal
Item No.	98782-010	98782-005
Material	Aluminium	Plastic
Weight	0,7 kg	0,2 kg
Dimensions	50x50 cm	50x50 cm

Rooflights

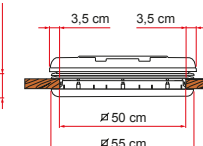
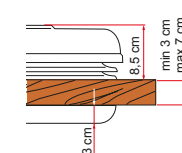
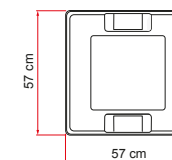
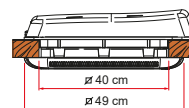
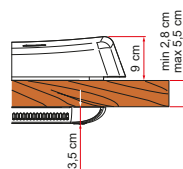
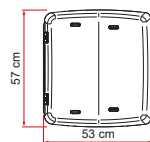
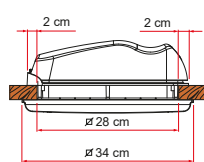
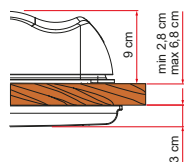
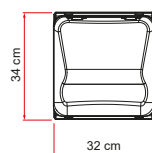

Description	Vent 28 F		Kit Turbo-Vent 28 F
Item No.	07902-01-	07902-01B	07903-01-
Cover	White	Crystal	-
Weight	1,8 kg		0,5 kg
Dimensions	28x28 cm		
Outside dimensions	32x34 cm		
Internal dimensions	31x34 cm		
Inside light	25x25 cm		
Roof thickness (min - max)	2,8 - 5,0 cm		
Roof thickness with Kit Extension min.-max.	5,0 - 6,8 cm		
Feeding tension	-	-	12 V
Absorbed power	-	-	25 W
Min. electric input	-	-	-
Max electric input	-	-	1,9 A
Max air flow	-	-	9 m ³ /min
Fan diameter	-	-	18 cm
Permanent air flow	80 cm ²		50 cm ²
Polar Control function	-	-	-
Touch function	-	-	-

Vent F Pro	Kit Turbo-Vent F Premium	Kit Turbo-Vent F	Kit Turbo-Vent F P3
07380-01-	07501-01-	07501A01-	07501B01-
White	White	White	White
4,7 kg		2,0 kg	
40x40 cm			
56,6x53,1x9,2 cm			
49x48,6x3,5 cm			
34,4x34,4 cm			
2,8 - 5,5 cm			
-		-	
-		12 V	
-		36 W	
-		0,3 A	
-		3 A	
-		35 m ³ /min	
-		30 cm	
100 cm ²		-	
-	●	●	-
-	●	-	-

Vent 50	
01668-01-	01668-01D
White	Crystal
4,7 kg	
50x50 cm	
3,0 - 7,0 cm	
-	-
-	-
-	-
-	-
-	-
-	-
-	-
-	-
-	-

Rooflights

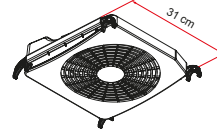
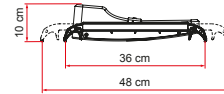
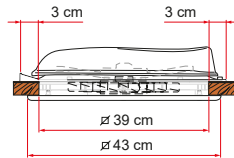
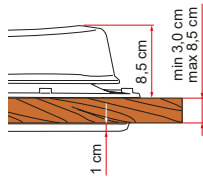
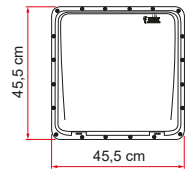

Vent		Turbo-Vent		Turbo-Vent Premium	
04328B01-	04328B01D	03623F01-	03623F01B	03623H01-	03623H01B
White	Crystal	White	Crystal	White	Crystal
2,8 kg		4,6 kg			
3,0 - 5,0 cm		3,0 - 4,5 cm		3,0 - 5,0 cm	
5,1 - 8,5 cm		4,5 - 8,5 cm		5,1 - 8,5 cm	
		12 V			
		36 W			
		0,3 A			
		3 A			
		35 m ³ /min			
		30 cm			
		80 cm ²			

Turbo-Kit
98683-059
1,3 kg
12 V
4 W
0,20 A
0,33 A
7,2 m ³ /min
24 cm

Rooflights accessories

[1] Spoiler Universal

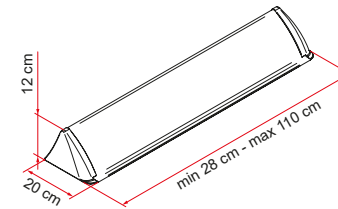

[2] Spoiler 40

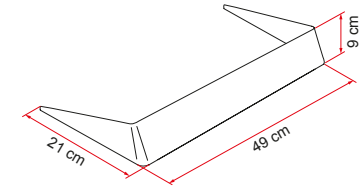

[1] Spoiler Universal	[2] Spoiler 40	[3] Thermo Vent 40	[4] Rollo Vent 40
06289-01-	03585-01-	03650A01-	06310-01-
1,4 kg	0,3 kg	0,1 kg	0,1 kg
26-110x20x12 cm	49x21x9 cm	40x40 cm	44,5x44,5 cm

[3] Thermo Vent 40

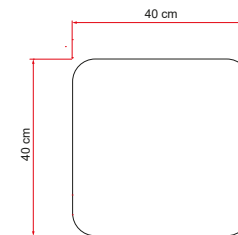

[4] Rollo Vent 40

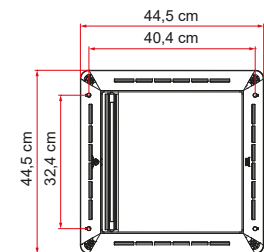

LED awning

[1] Awning Arms LED

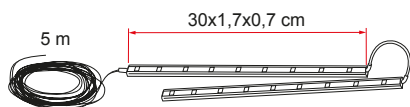

[2] Kit Awning LED

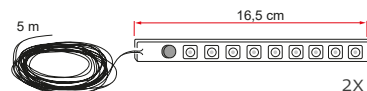

[3] - [4] Kit LED Strip Awning

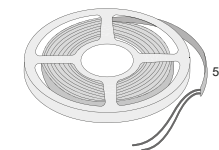
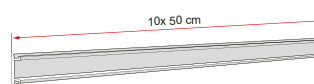

[5] LED Awning Case

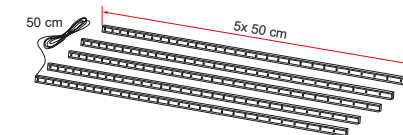

[6] LED Awning Case 50



[7] Rafter LED



[8] Rafter LED CaravanStore



Description	[1] Awning Arms LED	[2] Kit Awning LED	[3] Kit LED Strip Awning High Brightness	[4] Kit LED Strip Awning	[5] LED Awning Case	[6] LED Awning Case 50	[7] Rafter LED	[8] Rafter LED CaravanStore
Item No.	98655-849	98655-471	98655Z051	98655Z040	98655-914	98655-915	98655-850	98655-902
LED Colour	Cold white		Neutral white				Cold white	
Tone	6500° k		5000° k			6500° k		
Light Cone Angle	120°							
Lm/mt	382	170	840	420	168		792	
N° LED	18	9	300	150			36	
Feeding tension	12 V							
Absorbed power	4 W	2,4 W	48 W	24W	2,7 W / bar		9,7 W	
Electric input	0,36 A	0,20 A	4,00 A	2,00 A	0,23 A / bar		0,80 A	

Description	F45s	F45s VWT5/T6	F45L	F45eagle	F80s	F65s	F65L 018	F65L / F65eagle	Fiamma ZIP	CS / CS ZIP
Awning Arms LED	●	●	●	●	●	●	●	●	●	
Kit Awning LED	●	●	●	●		●			●	
Kit LED Strip Awning High Br.					●		●	●		
Kit LED Strip Awning					●		●	●		
LED Awning Case / 50	●		●	●					●	
Rafter LED	●	●	●			●	●		●	
Rafter LED Caravanstore										●

	Kit Cable Guide	Kit Cable Rail
Item No.	98655-903	98655-856
Weight	0,1 kg	

LED outdoor and garage

[1] LED Awning Light

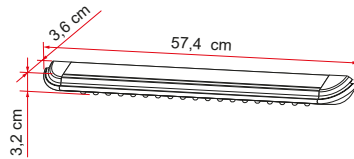

[2] LED Warning Solar

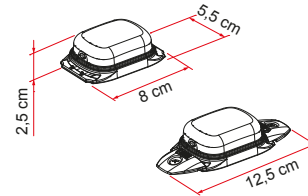

[3] LED Garage Light

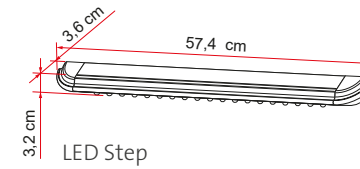

[4] LED Step

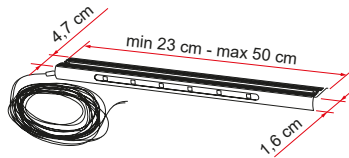

[5] LED Sensor Door Light

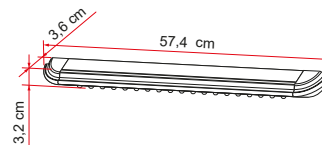

[6] LED Awning Light Gutter

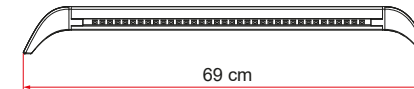

Description	[1] LED Awning Light	[2] LED Warning Solar	[3] LED Garage Light	[4] LED Step	[5] LED Sensor Door Light	[6] LED Awning Light Gutter
Item No.	98655-848	98655-885	98655-883	98655-886	98655A884	98655-607
LED Colour	Cold white	Intermit. red	Cold white			
Tone	6500° k	-	6500° k			
Light Cone Angle	120°					
Lm/mt	547	-	547	145	547	547
N° LED	31	6	31	6	31	31
Feeding tension	12 V	2,4 V	12 V			
Absorbed power	7,4 W	0,03 W	7,4 W	1,7 W	7,4 W	7,4 W
Electric input	0,62 A	0,012 A	0,62 A	0,14 A	wo,62 A	wo,62 A

Waterpumps and accessories

Aqua F (13 litres)

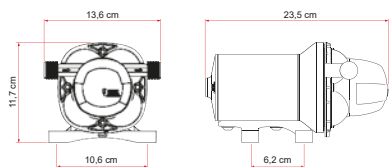

Aqua F (10 litres)

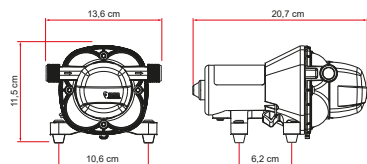

Aqua 8 (7 e 10 litres)

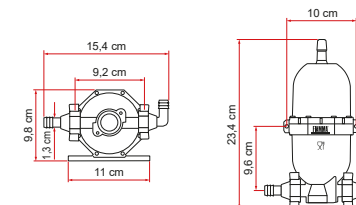
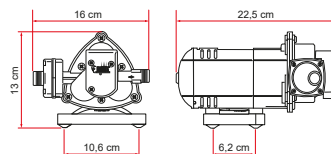

Description	Aqua F (13 litres)	Aqua F (10 litres)
Item No.	07073-01-	07073A01-
Weight	2,2 kg	1,4 kg
Power Supply	12 V	
Absorption	2,5 A	1,7 A
Max flow l/min. at 0 bar	13 l/min	10
Noise level	50 db	52 db
Pressure switch interv.	1,5 Bar - 21,7 Psi	
Section head	5 m	

Aqua 8 (7 litres)	Aqua 8 (10 litres)
01216C01-	01216B01-
1,5 kg	
12 V	
1,4 A	3,4 A
7 l/min	10 l/min
55/60 db	65/70 db
1,5 Bar - 21,7 Psi	

A20	Kit Connection Aqua F
02478-01-	98657-013
0,3 kg	0,3 kg

Tanks and accessories

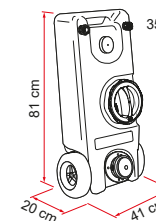
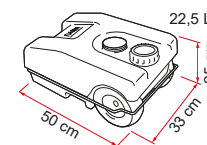
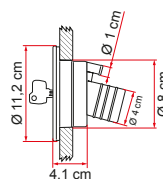
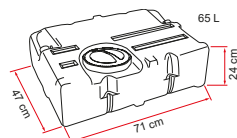
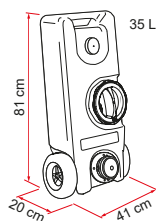
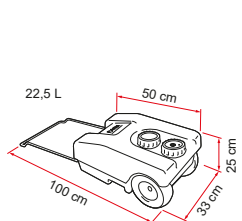

Description	Roll-Tank 23 F	Roll-Tank 40 F	Tank 70	Water Cap White	Water Cap Black
Item No.	02428A01A	08307-01A	08306-01-	94715-010	94715-005
Weight	2,4 kg	3,8 kg	4,4 kg	0,2 kg	
Capacity	22,5 l	35 l	65 l		-

Roll-Tank 23 W	Roll-Tank 40 W	Kit Sanitary Flex	Quick Connection W
02428A01-	08307-01-	02438A01-	06497-01-
2,4 kg	3,9 kg	0,8 kg	0,2 kg
22,5 l	35 l		-

Levelling systems and accessories

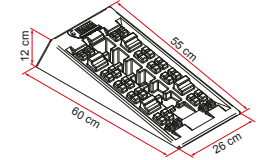
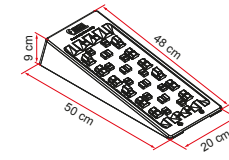
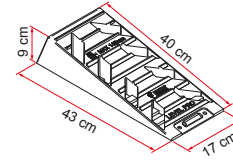
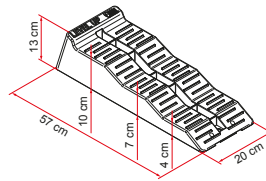
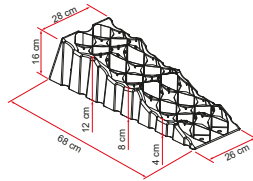
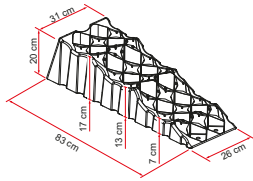

Description	Kit Level Up Premium	Kit Level Up Premium S	Level Up	Kit Level Up	Level Pro	Level System Magnum	Level System Jumbo
Item No.	97901-058	97901-062	97901-038	97901-059	97901-011	97901-015	97901-016
Colour	grey				yellow		
Dimensions	83x31x20 cm	68x28x16 cm	57x20x13 cm	57x20x13 cm	43x17x9 cm	50x20x9 cm	60x26x12 cm
Levels	3				-		
Max axle weight	5,0 t				8,0 t		
Overlapping	no				si		
Weight	3,7 kg each	2,3 kg each	1,45 kg each	1,45 kg each	0,8 kg each	1,3 kg each	2,9 kg each
Compatible with	Motorhome		Motorhome - Caravan - Suv Camper vans - Van conversions		Caravan - Camper vans	Motorhome - Caravan - Suv Camper vans - Van conversions	
Level Bag Premium	●						
Chock Level			○	○	○	○	
Anti Slip Plate			○	○	○	○	
Level Bag		●	○	●			
Level Bag S					○	○	
Level Plate			○	○			

● Standard ○ Optional

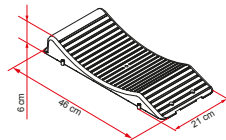
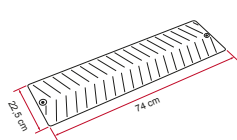

Description	Grip System	Wheel Saver
Item No.	97901-055	97901-013
Colour	grey	
Weight	0,4 kg each	0,6 kg each
Compatible with	Motorhome Van conversions	Motorhome - Caravan Van conversions

Description	Chock Level	Anti Slip Plate	Level Plate	Level Bag	Level Bag S
Item No.	97901-037	97901-012	97901-041	05950A02B	05950B02B
Colour	grey			black, grey, red	
Weight	0,1 kg	0,1 kg	0,3 kg	0,2 kg	0,2 kg
Compatible with	Level Up (Kit) - Level Pro - Level System Magnum	Level Up (Kit) - Level Pro - Level System Magnum - Wheel Saver	Level Up (Kit)	Level Up (Kit)	Level Pro - Level System Magnum - Wheel Saver

Levelling systems and accessories

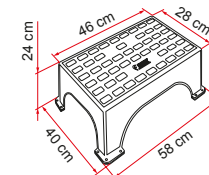
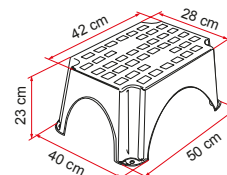
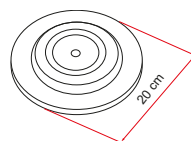
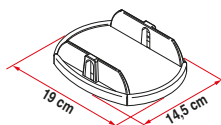
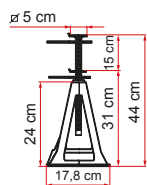
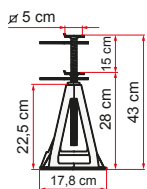

Description	Alu Jacks	Plastic Jacks	Plates Pro	Plates	Step	Step Magnum
Item No.	00680-01-	00680C01G	97901-057	97901-056	02950-01-	04630-01-
Colour	aluminium			grey		
Weight	0,9 kg each	0,8 kg each	0,2 kg each	0,2 kg. each	1,0 kg	1,3 kg
Max axle weight	1000 kg each	750 kg each	-	-	150 kg	200 kg

Description	Step-Mat	Step-Mat Magnum	Clean Step Green	Clean Step Black
Item No.	06373-01-	06374-01-	04593-01-	04593-01A
Colour	black		green	black
Weight	0,4 kg	0,5 kg	0,2 kg	0,2 kg

Organizer

Description	Item No.	Weight	Dimensions	Number of pockets	Triple Fixing	Function
Pack Organizer L	07512A01-	0,5 kg	88x39 cm	6	●	For little objects
Pack Organizer S	07512-01-	0,4 kg	50x84 cm	11	●	For little objects
Pack Organizer Toiletry	07515-01-	0,6 kg	30x37x11 cm / 30x118x11 cm	10		Container for bathroom fittings
Pack Organizer Seat	07514-01-	0,3 kg	43x66x2 cm	4		To hang up on the rear part of the seats of your vehicle
Pack Organizer Shoes	07513-01-	1,1 kg	84x54x2 cm	10	●	Container for shoes
Fix Organizer	98655-163	0,1 kg	5,5x3x1 cm	-	-	
Pack Waste	08202-01-	1,7 kg	29,5x29,5x42 cm	-	-	
Carry-Dog	08201-01-	2,8 kg	75x55x49 cm	-	-	
Pack Organizer Box	08207-01-	2,8 kg	60x36x31 cm	-	-	

Pocket

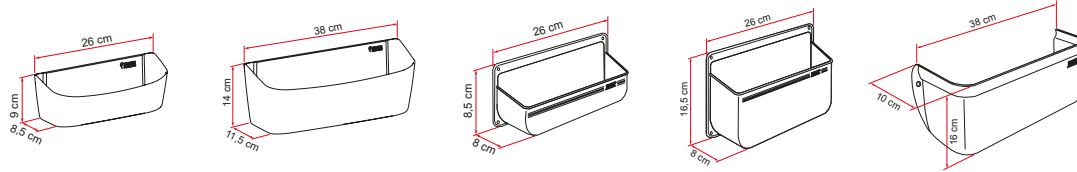

Description	Pocket Plus M	Pocket Plus L	Pocket M	Pocket L	Pocket XL
Item No.	08309-01-	08308-01-	03177-01-	03178-01-	03284-01-
Colour	grey		white		grey
Weight	0,1 kg	0,4 kg	0,1 kg		0,3 kg

Ultra-Box

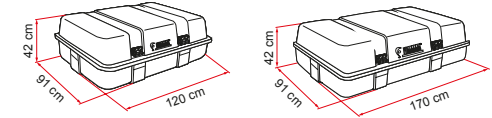

	Ultra-Box 2	Ultra-Box 3
Item No.	02084-01-	02085-01-
Weight	13 kg	17 kg
Volume	400 l	520 l
External dimensions	120x91x42 cm	170x91x42 cm
Internal dimensions	107,5x77,5x37,5 cm	155x77,5x37,5 cm

Fixing-Bar and accessories

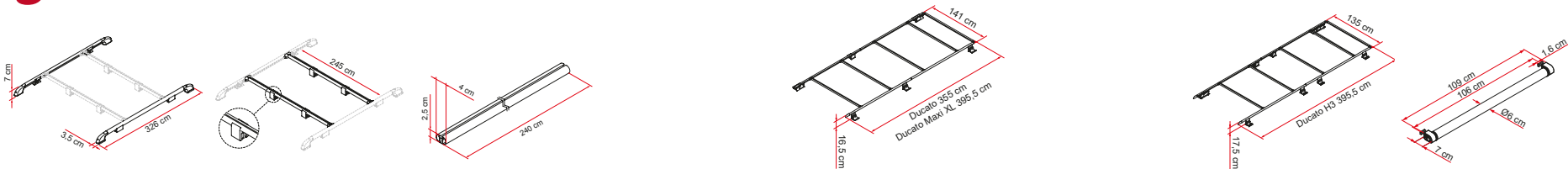

Description	Roof Rail	Fixing-Bar Rail	Fixing-Bar Pro L	Roof Rail Ducato * (h 16,5 cm)	Roof Rail Ducato * Deep Black (h 16,5 cm)	Roof Rail Ducato Maxi XL **	Roof Rail Ducato H3 ***	Roller Roof Rail
Item No.	05516-01-	98655-075	98655-295	05808-01-	05808A01A	05808-02-	05808-03-	06876-01-
Weight	4,7 kg	3,4 kg	1,5 kg	12,0 kg	12,0 kg	13,5 kg	14,2 kg	1,5 kg

Description	Kit Roof Rail Ducato Extra 16,5 cm	Kit Roof Rail Ducato Extra 14,5 cm	Kit Roof Rail Ducato Extra Cover	Kit Roof Rail Ducato Cover Left	Kit Roof Rail Ducato Cover Right
Item No.	98658-066	98658-097	98658-103	98658-101	98658-102
Bracket H	16,5 cm	14,5 cm			
Weight	1,0 kg			0,1 kg	

Roof Rail Ducato (05808-01-):
can be installed on Ducato vehicles with H2 high roof, L1, L2 and L3 lengths (to reach the desired length you can cut the 2 lateral bars, which are delivered as standard in L3 version)

Roof Rail Ducato Maxi XL (05808-02-):
for vehicles with H2 high roof and L4 length

Roof rail Ducato H3 (05808-03-):
version for Ducato with H3 high roof and L3 and L4 length.
Delivered as standard with 4 Fixing-Bar Rail

Garage

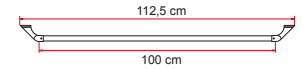
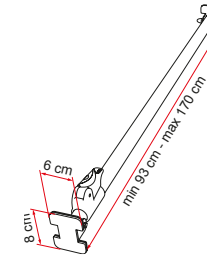
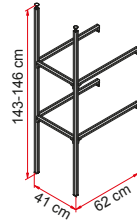
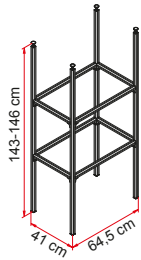

Description	Garage System Standard	Garage System Upgrade	Garage System Support	Garage Box (3 pz)	Kit Garage Wall Brackets	Luggage Bar	Garage Carry-Rail
Item No.	98655-907	98655-908	98656-772	98655-909	06667-01-	05411-03-	06112-01-
Weight	5,7 kg	3,9 kg	0,9 kg	5,6 kg	0,1 kg	0,7 kg	0,5 kg
Length					-	min 93 cm - max 170 cm	112,5 cm

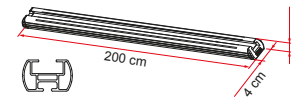
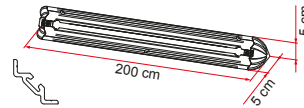
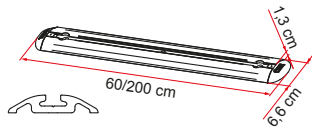

Description	Garage Bars Premium 200	Garage Bars Premium 60	Garage Bars Corner	Garage Bars	Kit Eye Premium/Corner (2 pcs.)	Kit Eye (2 pcs.)	Kit Square Plates (4 pcs.)
Item No.	98655-609	98655-608	98655-906	98655-480	98656-735	98656-494	98656-485
Weight	4,8 kg	2,2 kg	4,8 kg	3,1 kg	0,1 kg		
Kit Eye Premium/Corner	●/○		●/○				
Kit Eye				●/○			

Description	Cargo Strap	Kit Cargo Accessory
Item No.	05677-01-	98656-510
Weight	0,5 kg	0,1 kg

● Standard

○ Optional

Safe Door

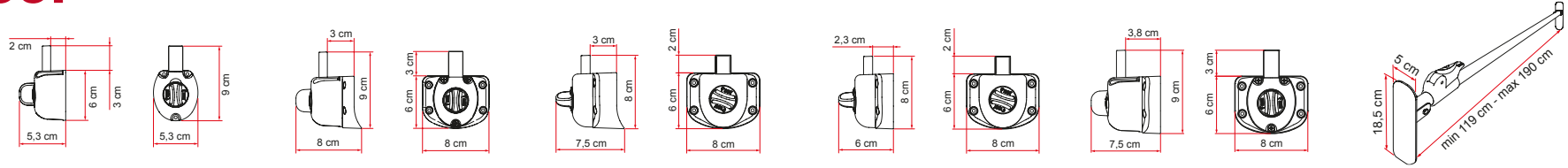

Description	Safe Door Guardian	Safe Door Guardian Ducato > 2009	Safe Door Guardian Ducato > 2006 < 2009	Safe Door Guardian Transit < 2006	Safe Door Guardian Transit > 2006 < 2014	Duo-Safe Pro
Item No.	05388-01-	05388-07-	05388-04-	05388-03-	05388-05-	05411-02-
Weight	0,3 kg	0,4 kg				1,0 kg

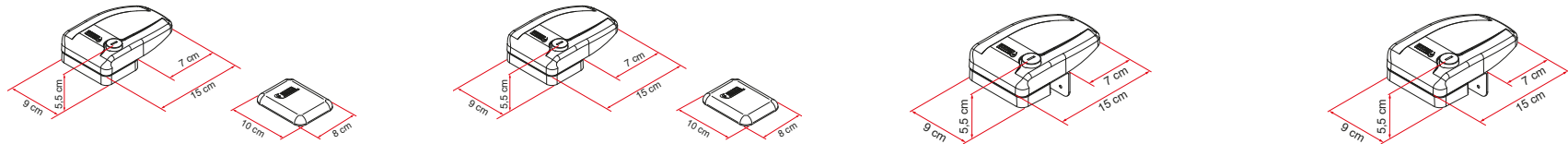

Description	Safe Door			Safe Door 3			Safe Door Frame			Safe Door Frame 3		
Item No.	08021-01-	08021-01G	08021-01A	08021-02-	08021-02G	08021-02A	08022-01-	08022-01G	08022-01A	08022-02-	08022-02G	08022-02A
Colour	white	grey	black	white	grey	black	white	grey	black	white	grey	black
Weight	0,6 kg			1,7 kg			0,5 kg			1,5 kg		
Door side frame	-			-			●			●		
One Key System	-			●			-			●		

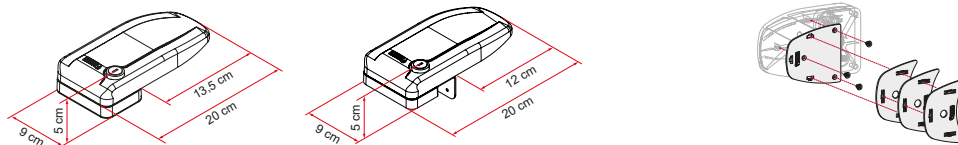

Description	Safe Door Mugnum	Safe Door Mugnum Frame
Item No.	08277-01-	08277A01-
Colour	white	
Weight	0,6 kg	
Door side frame	-	●
One Key System	-	-

Kit Spacer Safe Door >2017		
08230-01-	08230-01A	08230-01G
white	grey	black
0,1 kg		
-		
-		

● Standard

● Standard

Security

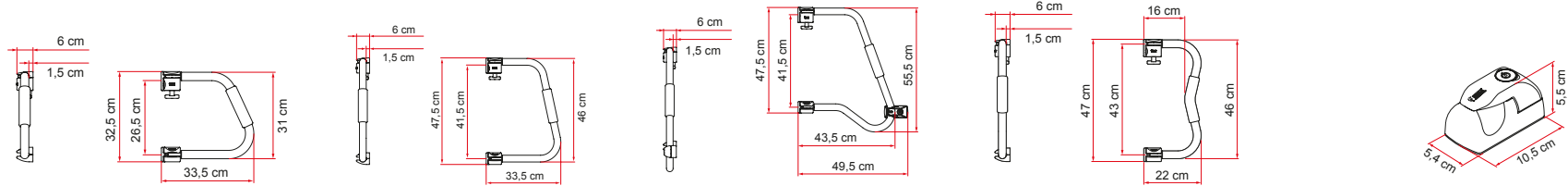

Description	Security 31	Security 46	Security 46 Pro	Security S	Kit Spacer Security Fendt	Kit Security Lock	Security Grip
Item No.	03513-01-	03513A01-	03513-04-	03513-05-	08101-01-	98656-433	07093-01-
Weight	1,1 kg	1,2 kg	1,7 kg	1,1 kg	0,2 kg	0,5 kg	0,4 kg
Colour	white				black	white	black
Kit Security	○	○	●	○			
Security Grip	●	●	●	●			

● Standard ○ Optional

Deluxe

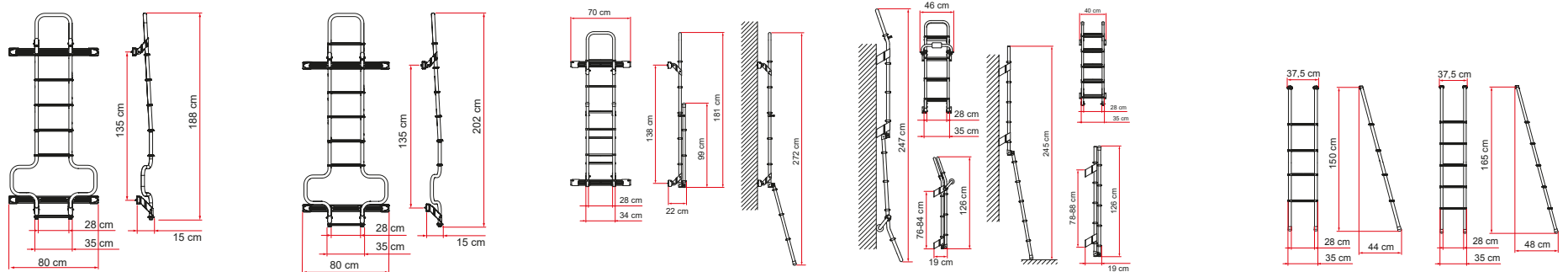

Description	Deluxe DJ	Deluxe DJ DB	Deluxe DJ H3	Deluxe DJ H3-DB	Deluxe Sprinter	Deluxe Sprinter DB	Deluxe 8	Deluxe 5D	Safe Ladder	Deluxe 4B	Deluxe 5B
Item No.	02426-09A	02426A09A	02426-17A	02426A17A	02426-19A	02426A19A	02426-02-	02426-08-	98656-480	02426-12-	02426-13-
Weight	6,5 kg		6,9 kg		7,0 kg		5,5 kg	4,9 kg	1,3 kg	2,4 kg	2,6 kg
Colour	aluminium	black	aluminium	black	aluminium	black	aluminium	aluminium	aluminium	aluminium	aluminium
Nr gradini	6		7		8		8	10	-	4	5
Pieghevole					●	●	●	●			

Cover

Description	Cover Premium M (up to 7,1 m)	Cover Premium L (up to 8 m)	Cover Top
Item No.	07916-01-	07917-01-	04932-01-
Weight	10,0 kg	11,0 kg	6,0 kg

Description	Thermoglas XXL Ducato > 2006	Thermoglas Ducato Windscreen	Thermo Wall Ducato Cabin >2006
Item No.	06344A01-	08041-01-	06585A01-
Weight	11,0 kg	5,0 kg	1,8 kg

Description	Coverglas XL Ducato > 2006	Coverglas VW T5/T6	Coverglas Ford Transit
Item No.	06344-01-	06344B01-	06344C01-
Weight	3,5 kg	3,5 kg	3,5 kg

Hygiene

Description	Super Kem Blue	Super Kem Sachets	Super Rinse	Soft 6
Item No.	97310-022	97310-023	97310-080	97312-010
Weight	2,0 kg	0,5 kg	0,7 kg	0,7 kg

Bi-Pot

Bi-Pot 30
SMALL

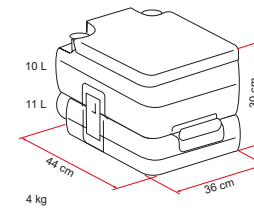

Bi-Pot 34
MEDIUM

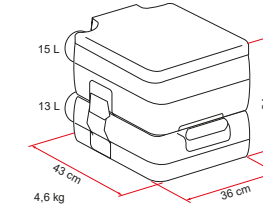

Bi-Pot 39
LARGE

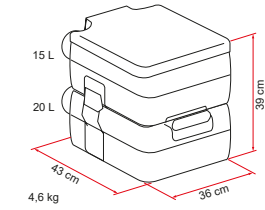

Description	Bi-Pot 30	Bi-Pot 34	Bi-Pot 39
Item No.	01356-01-	01354-01-	01355-01-
Weight	4,0 kg	4,6 kg	4,6 kg
Upper tank	10 l	15 l	15 l
Lower tank	11 l	13 l	20 l
Dimensions	43x34x30h cm	43x36x39h cm	43x36x39h cm
Colour	white		

Miscellaneous

Description	Moskito Net Pro	Moskito Net	Drip Stop 75			Drip Stop 200	Drip Stop 300		Drip Stop 500	Drip Stop 1000	
Item No.	07485-01-	03508-01-	03922-01-	03922-01G	03922-01A	03922E01A	03922A01-	03922A01G	03922F01A	03922D01-	03922D01G
Colour	-	-	white	grey	black	black	white	grey	black	white	grey
Weight	0,6 kg	0,5 kg	0,2 kg			0,6 kg	0,8 kg		1,2 kg	2,5 kg	

Description	Tube Pro	Tripod Pro	Conic Connection	Recessed Connection	Cap	Adapter Tube Pro	Mud Flap Front	Mud Flap Rear	Door Holder	Omni Stop
Item No.	06375A01-	06362-01-	C5063-01-	C0331-01-	02411-01B	98655-605	06606-01-	06607-01-	04663-01A	04912-01-
Weight	0,7 kg	1,0 kg	0,2 kg	0,1 kg			1,2 kg	1,2 kg	0,1 kg	0,1 kg





Products alphabetic index

A	
Azo	126-127
Alu Jacks	132-133
Alu Signal	108-109
Anti Slip Plate	131
Aqua F	126-127
Aqua 8	126-127
Awning Arms LED	122-123
B	
Bidet	149
Bike Cover Caravan	108-109
Bike Cover S / Premium S	108-109
Bike Frame Adapter	105
Bike-Block Pro S	104
Bike-Block Pro	105
Bi-Pot	148-149
Blocker Pro / Blocker	46-47
C	
Cable-Lock	106
CaravanStore / XL	32-33
CaravanStore Support Leg	76

CaravanStore ZIP XL	62-63
Cargo Back	110-111
Cargo Strap	141
Carry-Bike 200 D	94-95
Carry-Bike 200 DJ	94-95
Carry-Bike 200 DJ Sprinter / Crafter	94-95
Carry-Bike Backpack / 4x4	96-97
Carry-Bike Caravan Active / E-Bike	80-81
Carry-Bike Caravan Hobby	82-83
Carry-Bike Caravan Universal	82-83
Carry-Bike Caravan XL A	80-81
Carry-Bike Caravan XL A Pro	80-81
Carry-Bike Caravan XL A Pro 200	80-81
Carry-Bike Caravan XL A Pro 200 / E-Bike	80-81
Carry-Bike Frame Ducato E-Bike	92-93
Carry-Bike Frame VW Crafter E-Bike	92-93
Carry-Bike Ford Custom	90-91
Carry-Bike Ford Transit	90-91
Carry-Bike Garage Plus	98-99
Carry-Bike Garage Slide Pro Bike	98-99
Carry-Bike Garage Standard	98-99

Carry-Bike Pro C L80	78-79
Carry-Bike Lift 77 / E-Bike	76-77
Carry-Bike Mercedes Viano	88-89
Carry-Bike Mercedes Vito	88-89
Carry-Bike Mercedes V Class	88-89
Carry-Bike O. Vivaro / R. Trafic	90-91
Carry-Bike Pro / Pro C / Pro M	72-73
Carry-Bike Pro E-Bike / Pro C E-Bike	72-73
Carry-Bike Pro Autotrail	78-79
Carry-Bike Pro Hymer - Dethleffs	78-79
Carry-Bike PSA	90-91
Carry-Bike Renault Trafic D	90-91
Carry-Bike Simple Plus 200	82-83
Carry-Bike Trigano - CI - Roller Team	78-79
Carry-Bike UL / CL	74-75
Carry-Bike VW Caddy	86-87
Carry-Bike VW T2	86-87
Carry-Bike VW T3 (T25)	86-87
Carry-Bike VW T4 / T4 D	86-87
Carry-Bike VW T5 Pro / T6 Pro	84-85
Carry-Bike VW T5 / T6	86-87

Carry-Bike VW T5 D / T6 D	86-87
Carry-Dog	135
Carry-Moto / Pro	100-101
Carry-Ramp	100-101
Chock Level	131
Clean Step	133
Compass	36-37
Cover Premium	151
Cover Top	150
Coverglas	150
Crank Handle	41
Curtains Kit Smoke	67
D	
Deluxe	146-147
Dispenser	149
Door Holder	152-153
Door Pole	66
Drip Stop	152-153
Duo-Safe Pro	142-143
Dust Guard	107

E	
Easy Dry	108-109
F	
F35pro	34-35
F40van	30-31
F45eagle	28-29
F45L	18-19
F45s	14-15
F45s camper vans	16-17
F65eagle	30-31
F65L	26-27
F80s	24-25
Fiamma ZIP	60-61
Fix Organizer	135
Fixing-Bar Carry-Bike	107
Fixing-Bar Pro L	138
Fixing-Bar Rail	138
G	
Garage Bars	140-141
Garage Box	140-141
Garage Carry-Rail	179
Garage Pack / Plus	98-99
Garage System	140-141
Grip System	132-133
K	
Kit Upgrade T6 / T6.1 pro	85
Kit Upgrade T6 / T6.1	87
Kit Awning Hangers	40
Kit Awning LED	122-123
Kit Awning Pegs	40
Kit Awning Plate	40
Kit Cables Guide / Rail	158
Kit Cargo	141
Kit Dethleffs	79
Kit Eye	141
Kit Eye Premium / Corner	141
Kit Frame Cargo Back	110-111
Kit Garage Wall Brackets	140-141
Kit LED Awning Case 50	122-123
Kit LED Strip Awning / Brightness	122-123
Kit Level Up	130-131
Level Up Premium	130-131
Level Up Premium S	130-131
Kit Magic Privacy	66

Kit Poles	67
Kit Poles Light	67
Kit Premium S	103
Kit Rail Premium 48	103
Kit Rain Guard	78-79
Kit Repair Plus	41
Kit Sanitary Flex	129
Kit Security Lock	145
Kit Spacer Safe Door	143
Kit Spacer Security Fendt	145
Kit Square Plates	140-141
Kit Support Bar	107
Kit Turbo Vent 28 F	115
Kit Turbo Vent F / Premium / P3	116
Kit Upgrade E-Bike	72-73
L	
LED Awning Case	159
LED Awning Light	124-125
LED Awning Light Gutter	124-125
LED Garage Light	124-125
LED Sensor Door Light	125-125
LED Step	124-125
LED Warning Solar	124-125
Level Bag / S	131
Level Plate	131
Level Pro	130-131
Level System Magnum	130-131
Level System Jumbo	130-131
Level Up	130-131
Licence Plate Carrier	107
Luggage Bar	179
M	
Magicrofter / Pro	40
Mega Bag Elite / Smart	66
Moskito Net / Net Pro	152-153
Moskito Net Door	66
Moto Wheel Chock Front	100-101
Moto Wheel Chock Rear	100-101
Motor Kit	66-67
Mud Flap	152-153
O	
Omni Stop	152-153
P	
Pack Organizer	134-135

Pack Organizer Box	135
Pack Organizer Privacy	66
Pack Waste	134-135
Patio-Bag	41-66
Patio-Mat	41-66
Plastic Jacks	132-133
Plastic Signal	108-109
Plates / Plates Pro	132-133
Pocket Kassett	149
Pocket M / L / XL	136
Pocket Plus M / L	136
Privacy Rail Kit	67
Privacy Room	52-53
Privacy Room Light / CS Light	54-55
Privacy Ultra Light	56-57
Q	
Quick Connection W	129
Quick-Safe	106
R	
Rafter	40
Rafter Pro	40
Rafter CaravanStore / XL	40
Rafter LED / CaravanStore	122-123
Rail Premium / S / XL	102-103
Rail Premium S Fat Bike	102-103
Rail Quick Pro	102-103
Rail Quick C	102-103
Rail Strip Pro	102-103
Rain Caps	66
Rain Guard	42
Rear Door Cover	64
Rear Skirting	65
Roller Roof Rail	138
Rollo Vent 40	120
Roll-Tank	128-129
Room van	58-59
Roof Rail	138
Roof Rail Ducato	139
S	
Safe Door / Frame	142-143
Safe Door Guardian	142-143
Safe Door Magnum / Frame	142-143
Safe Ladder	146-147
Safety Strip	41

Security	144-145
Security Grip	145
Security Strip	106
Shade Sun View	46-47
Side W Pro	48-49
Side W Pro Shade	48-49
Side W Caravanstore	48-49
Skirting	65
Slide Out	22-23
Soft 6	149
Spoiler 40	120
Spoiler S	120
Spoiler Universal	155
Step / Step magnum	132-133
Step-Mat	133
Strip	106
Super Kem Blue	148-149
Super Kem Sachets	148-149
Super Rinse	148-149
Sun View Side	48-49
Sun View XL	46-47
T	
Table Legs	152-153
Tank 70	164
Thermo Vent 40	120
Thermo Wall Ducato Cabin	150
Thermoglas XXL Ducato	150
Tie Down / Tie Down S	41
Toilet Brush / Pro	149
Turbo-Kit	119
Turbo-Vent	117
Turbo-Vent Premium	117
U	
Ultra-Box 2/3	137
Ultra-Box 320-360-500	110-111
V	
Vent	117
Vent F Pro	116
Vent 28 F	114-115
Vent 50	118
W	
Water Cap	129
Wheel Saver	132-133



Fiamma SpA - Italy
Via S. Rocco, 56 - 21010 Cardano al Campo (VA)